

SIGNET PDA RANGE TECHNICAL SPECIFICATION

Wall-Mount Model Numbers: [PDA5/SW](#), [PDA7/SW](#), [PDA11/SW](#), [PDA5/DW](#), [PDA7/DW](#), [PDA11/DW](#).

Free-Standing Model Numbers: [PDA5/SD](#), [PDA7/SD](#), [PDA11/SD](#), [PDA5/DD](#), [PDA7/DD](#), [PDA11/DD](#).

POWER	
Supply Voltage:	230V ~ 50Hz (Free-standing model is supplied with IEC 320 fused mains lead; Wall-mount model is permanently connected to mains)
Power Consumption:	100W / 200W / 400W (model dependent)
INPUTS	
Line In:	Input impedance: 1k + or – input to ground. Sensitivity: -20dBu typical.
Microphone:	Input impedance: 1k + or – input to ground. Sensitivity: -42dBu typical. Phantom power for electret microphones: 12V selectable (on/off).
Outreach:	Input impedance: >10k. Sensitivity: 0dBu typical. Outreach power: 24V d.c. nom. is available via the amplifier's outreach connector (100mA max.)
OUTPUTS	
Loop 1 & Loop 2 (if fitted):	Type: True current mode. Loop output voltage: 14V. Single Loop drive current @ 1 ohm: 4.75A (PDA5/SD, PDA5/SW); 7.5A (PDA7/SD, PDA7/SW); 11A (PDA11/SD, PDA11/SW). Dual Loop drive current @ 1 ohm: 2 x 3.25A (PDA5/DD, PDA5/DW); 2 x 5A (PDA7/DD, PDA7/DW); 2 x 7.5A (PDA11/DD, PDA11/DW).
Line Out:	775mV output
Fault Relay:	Single pole double throw (SPDT): NC, Common, NO.
Phase Shift (if fitted):	2 x 90° phase shifted. Selectable (on/off).
Metal Compensation:	Up to 10dB / octave design counteracts frequency dependent absorption by metal in the installation over a bandwidth of approximately 5kHz.
COVERAGE	
Maximum Coverage Area: 200m ² ; i.e. rooms up to approx. 14m x 14m (PDA5/DD, PDA5/DW). 500m ² ; i.e. rooms up to approx. 22m x 22m (PDA7/DD, PDA7/DW). 1000m ² ; i.e. rooms up to approx. 31m x 31m (PDA11/DD, PDA11/DW). Loop impedance: 0.5 to 2 ohm.	
PERFORMANCE	
Frequency Response (-3dB): 100Hz to 5kHz; Distortion: Less than 1 % typical; Signal to Noise Ratio: Better than -65dB any input; AGC Range (3dB change in output voltage current): 10dB. AGC ratio: 20:1.	
SUPPLEMENTARY	
Sensitivity Level Controls (lockable):	Line Input, Microphone, 12V Phantom, Outreach, Metal Comp, Loop Drive 1, Loop Drive 2 (if fitted), Phase Shift (if fitted).
Display & Controls:	LED display with 4 membrane control buttons.
Connectors:	<ul style="list-style-type: none"> • Microphone (3-pin XLR Type - Free-standing model; 3-way pluggable connector - Wall-mount model). • Line In (3-pin XLR Type - Free-standing model; 3-way connector - Wall-mount model). • Loop (2 or 4 way binding post - Free-standing model; 2 or 4-way connector - Wall-mount model). • Outreach (4-way pluggable connector). • Line Out (3-way pluggable connector). • Fault Relay (3-way pluggable connector). • 230Va.c. connector (Mains lead supplied for Free-standing model; Fixed mains connection for Wall-mount model).
Overall Dims. (H x W x D):	Free-standing models: 67mm (H) x 218mm (W) x 280mm (D) Wall-mount models: 298mm (H) x 308mm (W) x 74mm (D)
Weight:	Free-standing models: 2.38kg; Wall-mount models: 3.35kg
Panel Construction:	Mild steel zintec, 1mm thick, black powder coated
Operating Temperature:	0°C to 40°C
	IP Rating (EN 60529): IP40 (indoor use only)
	Maximum Humidity: 95% non-condensing

SIGNET PDA RANGE HEARING LOOP AMPLIFIERS

Part Numbers:

[PDA5/SD](#), [PDA5/SW](#), [PDA7/SD](#), [PDA7/SW](#), [PDA11/SD](#), [PDA11/SW](#),
[PDA5/DD](#), [PDA5/DW](#), [PDA7/DD](#), [PDA7/DW](#), [PDA11/DD](#), [PDA11/DW](#)

SigNET PDA
Wall-Mount
Model



SigNET PDA
Free-Standing
Model

INSTALLATION & OPERATOR INSTRUCTIONS

THIS EQUIPMENT MUST BE INSTALLED AND MAINTAINED BY A SUITABLY SKILLED AND TECHNICALLY COMPETENT PERSON.

The SigNET PDA Range comprises of constant current, single and dual induction hearing loop amplifiers, each with an LED interface. The dual loop amplifiers have a built-in phase shifter, designed for 'phased array' induction loop systems. They may be free-standing, or wall-mounted and are designed to cover areas up to 200m², 500m² or 1000m² (model dependent).

Safety Guidelines and Important Notes	2
SigNET PDA Range Part Numbers and Kit Contents	3
Overview of the SigNET PDA Range Hearing Loop Amplifier	4
Amplifier Operation	5
Phased Array Hearing Loop Systems	6
Amplifier Connections	6-7
Mounting the Amplifiers	7-8
Connecting, Setting Up and Testing the System	9-11
SigNET PDA Range Technical Specification	12

 Manufacturer: SigNET AC Ltd, 6 Tower Road, Washington, Tyne & Wear NE37 2SH. www.signet-ac.co.uk.

E&OE. No responsibility can be accepted by the manufacturer or distributors of these power supplies for any misinterpretation of this instruction, or for the compliance of the system as a whole. The manufacturers policy is one of continuous improvement and we reserve the right to make changes to product specifications at our discretion and without prior notice.



Read these instructions before installation and operation

SAFETY GUIDELINES

The amplifiers must be installed indoors, positioned to avoid accidental damage and **MUST NOT** be subjected to excessive dust, conductive or corrosive gases or liquids, nor subject to temperatures, input voltages and electrical loads outside the stated operating range.

DO NOT dismantle or attempt to modify the amplifier, there are no user-serviceable fuses or parts inside the amplifier. For repair, please contact SigNET technical department.



WARNING: The surface of this unit may become hot during continued use.

- 1) Read these instructions.
- 2) Keep these instructions.
- 3) Heed all warnings.
- 4) Follow all instructions.
- 5) **WARNING:** To reduce the risk of fire or electric shock, do not expose this apparatus to rain or moisture.
- 6) Clean only with dry cloth.
- 7) Do not block any ventilation openings. Install in accordance with the manufacturer's instructions.
- 8) Do not install near any heat sources such as radiators, heat registers, stoves, or other apparatus (including amplifiers) that produce heat.
- 9) Protect the mains lead from being walked on or pinched particularly at plugs, convenience receptacles, and the point where they exit from the apparatus.
- 10) Only use attachments/accessories specified by the manufacturer.
- 11) Unplug this apparatus during lightning storms or when unused for long periods of time.
- 12) Refer all servicing to qualified service personnel. Servicing is required when the apparatus has been damaged in any way, such as the mains lead or plug is damaged, liquid has been spilled or objects have fallen into the apparatus, the apparatus has been exposed to rain or moisture, does not operate normally, or has been dropped.

IMPORTANT NOTES

These instructions are general and cannot be considered to cover every aspect of hearing loop system design and installation.

We recommend you read BS 7594 - Code of practice for audio-frequency induction-loop systems (AFILS) and BS EN 60118-4 - Induction loop systems for hearing aid purposes. Other national standards of design/installation/commissioning should be referenced where pertinent.



This product has been manufactured in conformance with the requirements of all applicable EU directives.

Equipment guarantee

This equipment is not guaranteed unless the system is installed and commissioned in accordance with regional or national standards by an approved and competent person or organisation.

General Operation

The amplifier mixes and amplifies the microphone, line in, outreach input signals and feeds them through its sophisticated automatic gain control (AGC) circuitry before outputting them to the hearing loop(s).

8

Testing the System

Using a hearing loop test receiver, listen to the loop signal in all areas where coverage is required (we recommend you use a Fosmeter Pro for this purpose, see 'Additional Testing' below). If the signal level is not acceptable, adjust the **LOOP1 and LOOP2** (if fitted) levels in small increments until it is.



9

Additional Testing

Hearing loop systems require careful testing and calibration before operation. BS EN 60118-4 recommends that the achievable magnetic field strength of a hearing loop system over a 'covered area' should be 400mA RMS per metre.

We recommend you check the loop system using a **400mA Fosmeter Pro Induction Loop Test Kit (Part No. FPROK1)**.

This kit includes a handheld Fosmeter Pro 400mA magnetic field strength meter, a loop listener and a signal generator. Please contact your distributor/supplier for purchasing information.

4

Connect Power

Connect the mains lead (supplied) to a 230Va.c. wall socket and the amplifier's 230Va.c. connector. Switch on power and the amplifier will be unlocked with functions available to select.

Note: The amplifier will remember and retain its last settings if it is powered down.

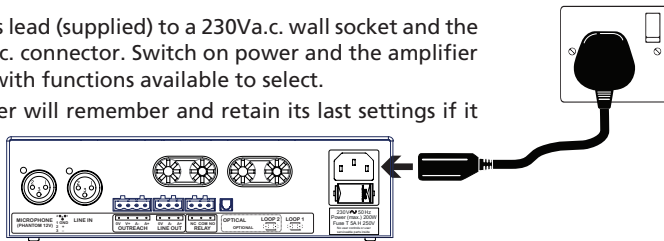

5

Set up the Amplifier's Inputs

Note: On initial power up, the amplifier's inputs and outputs are factory set to their lowest settings.

Activate all relevant audio input source(s), i.e. mic., line in and outreach.

Select the relevant function using **SELECT** ▼ & ▲ buttons, e.g. **LINE**, and use the **OFF** ◀ & **ON** ▶ buttons to adjust the signal level until the **LIMIT** indicator flashes occasionally, as shown below.

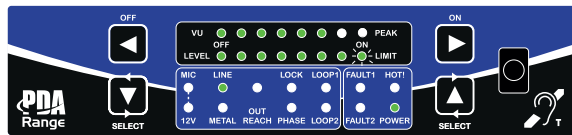

Repeat this procedure by selecting the relevant function and adjusting the signal level. If a microphone is used, enable phantom power by selecting **12V** on the LED display. Also, enable **PHASE** (if fitted) on the display for phased array systems.

6

Set up the Loop Drives

Select the **LOOP1** function and use the **ON** ▶ button to increase the loop field strength, as shown below. For dual loop amplifiers, select the **LOOP2** function and repeat this procedure.

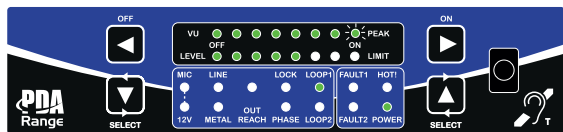

CAUTION: Ensure the **PEAK** indicator is not permanently lit. This may cause the amplifier to shutdown to protect it from overheating.

7

Metal Compensation

For applications with high metal content in, or near, the hearing loop, select the amplifier's **METAL** function. Increase the metal compensation by small increments using the **ON** ▶ button until a natural balance is achieved.

Note: If high metal content is present, the amplifier's area of coverage will be reduced, and further reduced, as the metal compensation level is increased.

SIGNET PDA RANGE PART NUMBERS

Part No.	Description
SINGLE LOOP AMPLIFIERS	
PDA5/SD	Free-Standing, Hearing Loop Amplifier with LED Interface, Single Loop 4.75 Amp (230V Mains Lead Connection)
PDA5/SW	Wall-Mount, Hearing Loop Amplifier with LED Interface, Single Loop 4.75 Amp (230V Fixed Mains Connection)
PDA7/SD	Free-Standing, Hearing Loop Amplifier with LED Interface, Single Loop 7.5 Amp (230V Mains Lead Connection)
PDA7/SW	Wall-Mount, Hearing Loop Amplifier with LED Interface, Single Loop 7.5 Amp (230V Fixed Mains Connection)
PDA11/SD	Free-Standing, Hearing Loop Amplifier with LED Interface, Single Loop 11 Amp (230V Mains Lead Connection)
PDA11/SW	Wall-Mount, Hearing Loop Amplifier with LED Interface, Single Loop 11 Amp (230V Fixed Mains Connection)
DUAL LOOP AMPLIFIERS	
PDA5/DD	200m ² Free-Standing, Phase-Shifted, Hearing Loop Amplifier with LED Interface, Dual Loop 2 x 3.25 Amp (230V Mains Lead Connection)
PDA5/DW	200m ² Wall-Mount, Phase-Shifted, Hearing Loop Amplifier with LED Interface, Dual Loop 2 x 3.25 Amp (230V Fixed Mains Connection)
PDA7/DD	500m ² Free-Standing, Phase-Shifted, Hearing Loop Amplifier with LED Interface, Dual Loop 2 x 5 Amp (230V Mains Lead Connection)
PDA7/DW	500m ² Wall-Mount, Phase-Shifted, Hearing Loop Amplifier with LED Interface, Dual Loop 2 x 5 Amp (230V Fixed Mains Connection)
PDA11/DD	1000m ² Free-Standing, Phase-Shifted, Hearing Loop Amplifier with LED Interface, Dual Loop 2 x 7.5 Amp (230V Mains Lead Connection)
PDA11/DW	1000m ² Wall-Mount, Phase-Shifted, Hearing Loop Amplifier with LED Interface, Dual Loop 2 x 7.5 Amp (230V Fixed Mains Connection)

Free-Standing Model Kit Contents

- 1 x Hearing loop amplifier (part numbers listed above)
- 1 x Fused 230V mains lead
- 1 x Accessory pack containing instructions (this document), four self-adhesive rubber feet, pluggable connectors (for the outreach, line out & relay terminals), 'hearing loop fitted' sticker.

Wall-Mount Model Kit Contents

- 1 x Hearing loop amplifier (part numbers listed above)
- 1 x Accessory pack containing instructions (this document), two ferrite beads (for the loop cables), pluggable connectors (for the outreach, line out, relay, line in & microphone terminals), 'hearing loop fitted' sticker.

OVERVIEW OF THE SIGNET PDA RANGE HEARING LOOP AMPLIFIER

Note: See page 7 for alternative wall-mount model connections.

Connections (Free-Standing Model Shown)

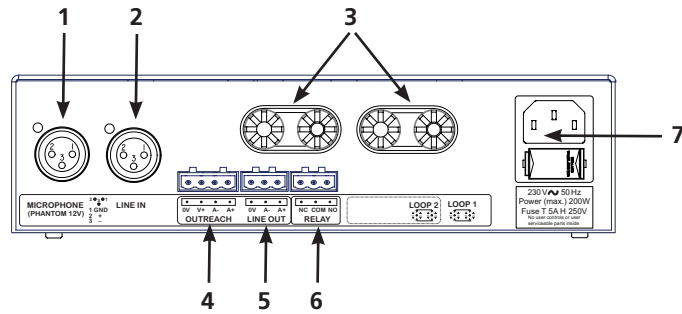

Rear Connectors

1	Microphone:	Accepts standard three-pin male XLR type connector. Optional 12V phantom power is available for electret microphones.
2	Line In:	Accepts standard three-pin male XLR type connector.
3	Loop 1 & Loop 2 (if fitted):	Induction Loop Connectors 1 & 2. Heavy duty binding posts.
4	Outreach:	4-way connector. Input for the outreach plate audio input system (see page 6 for further details).
5	Line Out:	3-way connector for audio output.
6	Relay:	Fault relay provides contacts for remote fault monitoring.
7	AC Power Input:	230Va.c. mains lead connector.

CONNECTING, SETTING UP AND TESTING THE SYSTEM

Note: Free-standing model connections are shown in the steps below. See pages 7 to 8 for alternative wall-mount model connections.



IMPORTANT: DO NOT power up the system before completing Step 3 below. The amplifier MUST NOT be operated without a loop connected to it.

- 1 Install Loop 1 Cable and Loop 2 Cable (if fitted)**
 See 'Phased array hearing loop systems', page 6 for example dual loop layouts. BEFORE connecting the loops to the amplifier, use a multimeter to check the loops are not shorted to ground at any point. It WILL damage the amplifier if a loop is shorted.

- 2 Connect Loop 1 Cable and Loop 2 Cable (if fitted)**
 Connect the loop(s) to the amplifier's binding posts using bare wire ends, 4mm plugs or spade terminals as appropriate.

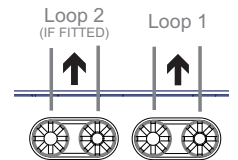

- 3 Connect Input Signal Sources (model dependent)**
 Connect the relevant input signal sources, e.g. microphone, line in, and outreach to the amplifier, as shown below.

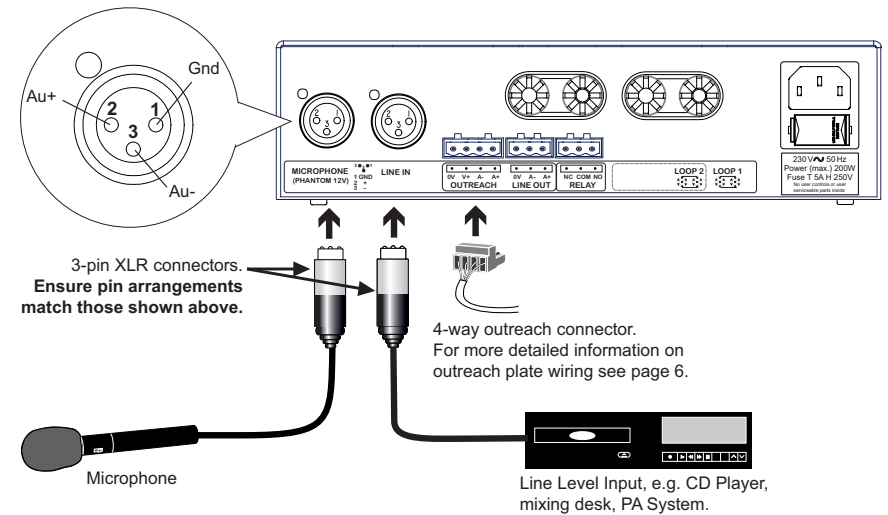

Wall-Mount Model Nos. PDA5/SW, PDA7/SW, PDA11/SW, PDA5/DW, PDA7/DW, PDA11/DW



WARNING: DO NOT ATTEMPT TO CONNECT MAINS SUPPLY TO THE AMPLIFIER UNLESS ALL COMPONENTS ARE SECURELY INSTALLED IN THE ENCLOSURE! THIS IS A PIECE OF CLASS 1 PERMANENTLY CONNECTED EQUIPMENT AND MUST BE EARTHED.

Mounting

Using the five mounting holes provided, mount the metal base securely onto a vertical wall, ≤2m mounting height. Assess the condition and construction of the wall and use suitable screw fixings for the in-service weight of the product. The mounting holes are suitable for use with Ø4-5mm countersunk screws. Any dust or swarf created during the mounting process must be kept out of the enclosure and due care must be taken not to damage any wiring or components.

Remove knockouts

Decide how the wiring will be brought into the amplifier and remove the required knockouts for cable entry. A typical SigNET PDA system would require knockouts for 230Va.c. mains, loop cable(s), microphone, line in and outreach plates. Knockouts should be removed with a sharp, light tap using a 6mm flatbladed screwdriver. If a knockout is removed fill the hole with a good quality 20mm strain relief, cable gland.

Observe proper segregation of wiring

Mains, loop and low power wiring must not come into contact, i.e. do not feed wiring through the same gland or allow wires of one type of connection to cross those of another.

The amplifier is surface mounted using the five mounting holes in the unit's base (shown below). Mounting holes are designed for Ø4-5mm countersunk screws.

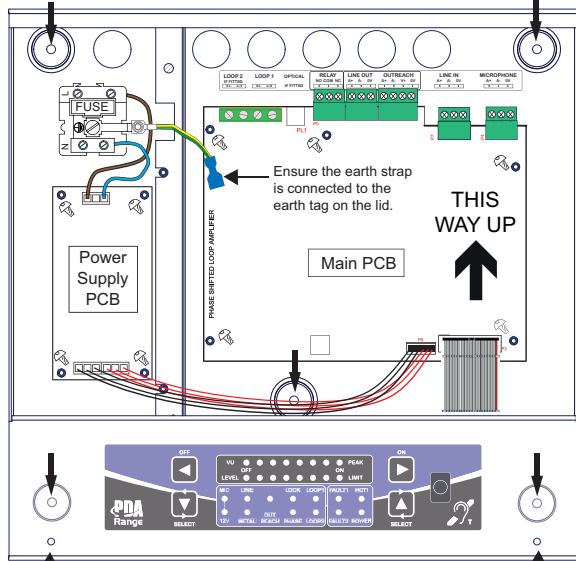

The metal lid may be removed for ease of mounting. Undo the two screws at the top of the front panel using a pozidriv screwdriver.

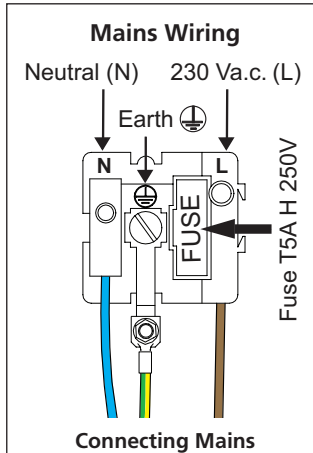

Terminate the mains input cable (Live, Neutral, Earth) to the fixed mains connector in the base of the enclosure (shown left and above).

The 230Va.c. cable **MUST** enter the enclosure via one of the knockouts at the top left-hand corner of the enclosure.

All wiring should be installed in accordance with the current edition of the IEE Wiring Regs (BS 7671), or relevant local/national standards. This equipment requires fixed wiring using three core cable (≥1.0mm², <2.5mm²), fed from an isolating switched fused spur at 3A, or a 6A Type B circuit breaker to IEC/EN 60898-1, or suitable fuse.

AMPLIFIER OPERATION

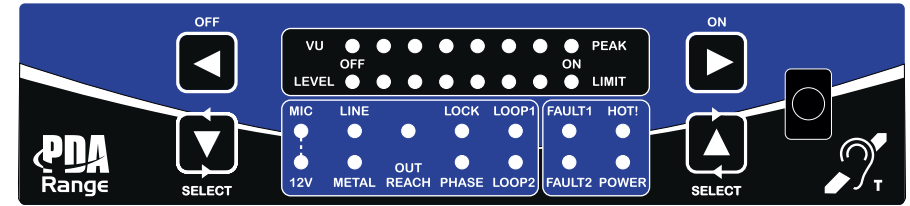

- Use **SELECT ▼** & **▲** buttons to select the function you want to adjust.
- Use **OFF ◀** & **ON ▶** buttons to adjust the setting for the selected function. Current selection is indicated by an LED light at that position.
 - With **MIC** selected, **◀** & **▶** adjust the microphone input level.
 - With **LINE** selected, **◀** & **▶** adjust the line input level.
 - With **LOCK** selected, **◀** & **▶** unlock or lock the amplifier.
 - Note:** The unlock code is **▶▶◀◀**, i.e. **RIGHT-RIGHT-LEFT-LEFT**.
 - With **LOOP1** selected, **◀** & **▶** adjust the current output for loop 1.
 - With **LOOP2** selected, **◀** & **▶** adjust the current output for loop 2 (if fitted).
 - With **PHASE** selected, **◀** & **▶** turn off or on the phase shift between loop 1 and loop 2.
 - With **OUTREACH** selected, **◀** & **▶** adjust the outreach input level.
 - With **METAL** selected, **◀** & **▶** adjust the metal compensation level.
 - With **12V** selected, **◀** & **▶** turn off or on the microphone phantom power.
- When a function with a level is being adjusted, the row of LEDs between **LEVEL** & **LIMIT** will progressively light up with **▶** or turn off with **◀**. The number of LEDs lit up indicates the strength of the function, e.g. the mic volume.
- When a function that is either on or off is being adjusted, the LED under **OFF** indicates that the function is off and the LED under **ON** indicates that the function is on.
- **Indicators**
 - **VU** – the row of LEDs to the right of **VU** are a VU meter showing the instantaneous amplitude of the audio.
 - If **LOOP1** is selected, the VU meter shows the amplitude of loop 1 current.
 - If **LOOP2** is selected, the VU meter shows the amplitude of loop 2 current (if fitted).
 - **HOT!** indicates that the output stage is getting hot. In normal operation this is unlikely to occur but may happen during installation when the loop performance is being adjusted or measured with a sine wave input. The loop amplifier will continue to function normally while **HOT!** is lit, but it indicates that output stage may shut down to protect from overheating.
 - **FAULT1** indicates that loop 1 has shut down because of either overheating or excessive current.
 - **FAULT2** indicates that loop 2 (if fitted) has shut down because of either overheating or excessive current.
 - **POWER** indicates that the loop amplifier is receiving mains power.

PHASED ARRAY HEARING LOOP SYSTEMS (MODEL DEPENDENT)

Increasingly to ensure uniformity of the magnetic field, especially in larger installations where large amounts of metal are present and to limit overspill, phased array loop systems are being specified. A phased array system works by producing two AFILS signals 90° out of phase with each other. These signals are connected to two identical hearing loops laid in a special overlapping pattern. The resultant magnetic field is evenly spread within the covered area but falls off quickly outside the loop.

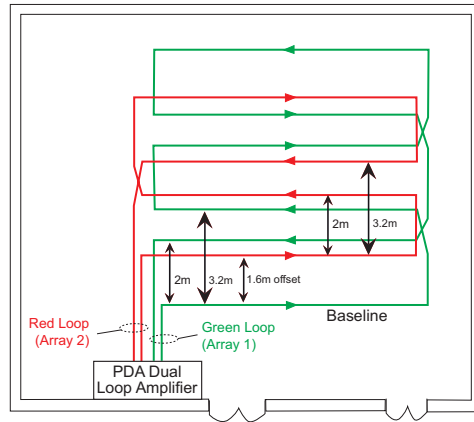

The SigNET PDA Range amplifiers offer:

1. A true 'all-in-one' professional phased-array AFILS solution.
2. An onboard overspill reduction phase shifter and metal compensation control.
3. An internal PSU.

See diagram above for a typical dual loop design. For further advice on phase shifted loop design please contact SigNET technical department.

AMPLIFIER CONNECTIONS

Outreach Connector

The SigNET PDA Range amplifiers are fully compatible with the outreach plate audio input extension system. This system allows the connection of multiple microphones, or line level inputs via a range of specially designed wall, ceiling or desk-mountable single gang plates.

Up to ten outreach plates (any mix) can be daisy-chained to the amplifier's 'outreach' connector with cable lengths up to 100m (total network length) easily achievable using standard two pair audio cable such as Belden 8723 - see typical wiring diagrams.

Please contact SigNET technical department for more information.

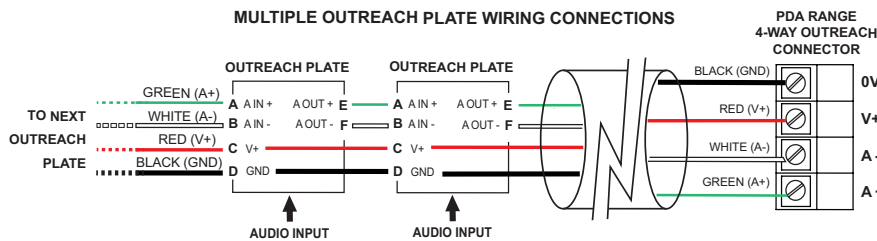
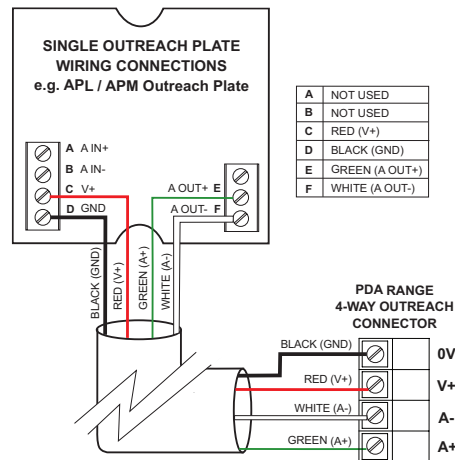

Line Out Connector

This output may be used to connect multiple SigNET PDA Range hearing loop amplifiers to cover larger areas.

The audio line output should be wired with signal +Ve from A+, signal -Ve from A- and screen from 0V, as shown right.

The amplifier mixes and amplifies the microphone, line in, outreach input signals and sends this signal through the Line Out connector before feeding them through the AGC circuitry.

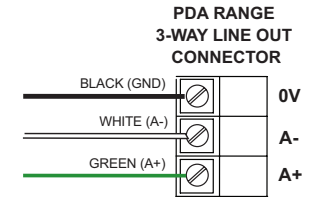

Loop Connectors (Wall-Mount Model Only)

The loop cable should be laid in a single turn (unless otherwise instructed by SigNET technical department) and wired into the amplifier's terminal block labelled LOOP1 and LOOP2 (if fitted), as shown right.

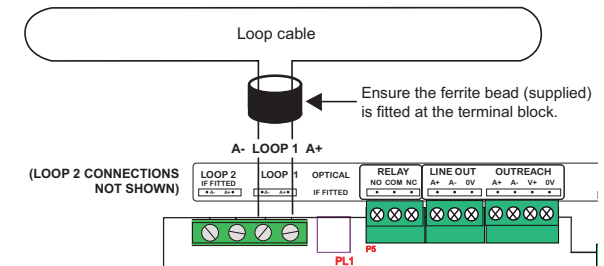

Microphone Connector (Wall-Mount Model Only)

A Mic level input should be wired to the amplifier's Microphone input, as shown right.

Unbalanced microphones should be wired as signal +Ve to A+, screen to 0V and A- linked to 0V. Balanced microphones should be wired to 0V, A- and A+ (A+ carries the 12 V phantom power).

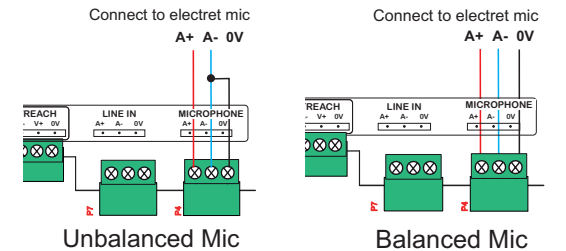

Line In Connector (Wall-Mount Model Only)

Unbalanced line level inputs should be wired as shown right with signal +Ve to A+, screen to 0V and A- linked to 0V.

Balanced line level inputs should be wired using outreach plates (detailed on page 6).

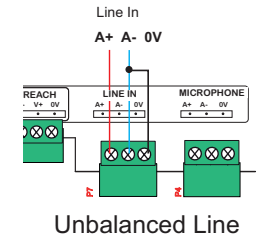

MOUNTING THE AMPLIFIERS

Always refer to the Safety Guidelines (page 2) before deciding on a location for the amplifier.

Free-Standing Model Nos. PDA5/SD, PDA7/SD, PDA11/SD, PDA5/DD, PDA7/DD, PDA11/DD

These amplifiers have been designed so they can be left free-standing on a shelf, tabletop or desk. The four rubber feet provided in the amplifier's accessory pack should be stuck to the underside of the amplifier.