

Digi-Wave™ 400 Series

Digital Transceiver and Receiver

USER MANUAL



DLT 400

DLR 400

Digi-Wave™ 400 Series

DLT 400 Digital Transceiver and DLR 400 Digital Receiver

Contents

Safety Warnings and Recycling Instructions	3
System Overview.....	4
DLR 400 ALK Differences	4
DLT 400 Controls and Connectors	5
DLR 400 RCH Controls and Connectors.....	5
General Operation.....	6
Before Programming the Digi-Wave™ System.....	7
The Main Screen.....	9
Setting Up the Digi-Wave™ System	10
Language.....	10
Initial Setup.....	10
Changing Settings.....	11
Basic Settings	11
Advanced Settings	11
Interpretation Mode Features	15
Floor and Interpreter.....	15
Repeater Broadcast Mode	15
Standard Interpretation Mode	16
Bilingual Mode.....	17
Relay Mode	18
Court Mode	18
Saving and Replacing Profiles.....	20
Differences between DLT 400, DLT 300, DLT 100 2.0 & DLT 100.....	20
Microphone/Headset Jack Difference.....	21
Differences Between Historical Digi-Wave DLTs.....	21
Updating DLT 400 and DLR 400 RCH Firmware	22
Troubleshooting.....	23
Specifications - DLT 400 Transceiver.....	24
Specifications - DLR 400 RCH Receiver.....	25
Specifications - DLR 400 ALK Receiver.....	25
Regulatory Statements.....	27
2-Year Warranty	29

Safety Warnings and Recycling Instructions

HEARING SAFETY

CAUTION!

This product is designed to amplify sounds to a high volume level which could potentially cause hearing damage if used improperly. To protect your hearing and the hearing of others:

1. Turn the volume down before putting on the earphone or headphone, and then adjust the volume to a comfortable level,
2. Set the volume level at the minimum setting that you need to hear,
3. If you experience feedback (a squealing or howling sound), reduce the volume setting and move the microphone away from the earphone or headphone.
4. Do not allow children or other unauthorized persons to have access to this product

MEDICAL DEVICE SAFETY

CAUTION!

1. Before using this product with an implantable or other medical device, consult your physician or the manufacturer of your implantable or other medical device.
2. If you have a pacemaker or other medical device, make sure that you are using this product in accordance with safety guidelines established by your physician or the implantable device manufacturer.

BATTERY SAFETY

CAUTION!

DLT 400 and DLR 400 RCH internal battery pack.

To reduce the risk of fire or burns, do not attempt to open, disassemble, or service the battery pack. Do not crush, puncture, short contacts or dispose of in fire or water. Do not incinerate or expose to temperatures above 140°F (60°C). Replace only with battery pack designated for this product: a rechargeable Lithium-polymer battery. Recycle or dispose of properly.

CAUTION!

The lithium batteries used in the DLT 400 and DLR 400 RCH provide great performance and long life. But, like all lithium batteries, they do have a limited number of charge/discharge cycles. Lithium batteries may experience swelling if used beyond their expected life cycle (2 years). If you notice swelling of the battery, please discontinue use and have the battery replaced. We recommend battery replacement after 2 years of use. For more information about replacing the battery, please visit our website at: <http://www.williamsav.com/digiwave-battery-replacement>.

RECYCLING INSTRUCTIONS



Battery Safety and Disposal

Help Williams AV protect the environment! Please take time to dispose of your equipment properly. Please do NOT dispose of batteries in the household trash. Please take the batteries to a retail or community collection point for recycling.



Product Recycling:

Please do NOT dispose of your Williams AV equipment in the household trash. Please take the equipment to an electronics recycling center or return the product to the factory for proper disposal.

System Overview

The Digi-Wave communication system allows users to listen and talk to one another wirelessly in a variety of scenarios. A Digi-Wave system consists of at least one transceiver (DLT 400) and various combinations of transceivers and receivers (DLR 400).

The DLT 400 is a two-way transceiver, meaning that it can transmit and receive audio simultaneously.

The DLR 400 is a receiver only. Users of DLR 400 receivers can only hear what is being broadcast by DLT(s); they cannot create any audio. There are two models of DLR: the DLR 400 ALK and the DLR 400 RCH. For information on the differences, see “DLR 400 ALK Differences” on page 4.

For simplicity, throughout the rest of this manual, the DLT 400 may be referred to as a “DLT.” The DLR 400 RCH and DLR 400 ALK as a “DLR” when the behavior of both devices is the same.

Combinations of one or more DLT’s and DLR’s can be used to facilitate different events, depending on what needs to be spoken and what needs to be heard. Examples of scenarios will be covered here.

Typical Scenarios include:

- Guided Tours - with one or more tour guides (2-way), with audience participation (2-way), or without audience participation (1-way)
- Language Interpretation - one or more interpreted languages transmitted to audience (1-way)
- Intercom - with up to six people able to speak simultaneously (2-way)

There are many more scenarios than are covered in this manual, however these would be variations on the ones discussed here.

Backwards Compatibility

The Digi-Wave 400 Series is backward compatible with the 300 series with limited features.

It is **not** backward compatible with any earlier transceivers or receivers (DLT 100, DLT 100 2.0, DLR 50, DLR 60, and DLR 60 2.0).

The Technology

The Digi-Wave™ system is a digital spread-spectrum (DSS), simultaneous two-way wireless listening system operating in the 2.4 GHz band. Due to its frequency-hopping algorithm, it avoids interference and is a very secure method of communication. For a more detailed explanation of how Digi-Wave technology works, please visit our website and download the “Digi-Wave™ Technology White Paper”.

DLR 400 ALK Differences



The DLR 400 ALK uses 2 AAA alkaline batteries rather than a rechargeable battery like the DLR 400 RCH.

The AAA alkaline batteries can be inserted by removing the panel on the back of the device and putting the batteries in place with the correct polarity. When changing batteries, always change both batteries at the same time.

Help Williams AV protect the environment! Please recycle batteries once they are drained.

Other Differences

The DLR 400 ALK allows you to select a group via the up and down arrows on the front of the device. The volume may be adjusted using the vol buttons. There is no menu system otherwise.

The battery and signal strength indicators on the screen work similarly to the DLR 400 RCH, but are located on the far left of the screen.

When discussing DLR Receivers, this manual is usually referring to the DLR 400 RCH.

DLT 400 Controls and Connectors

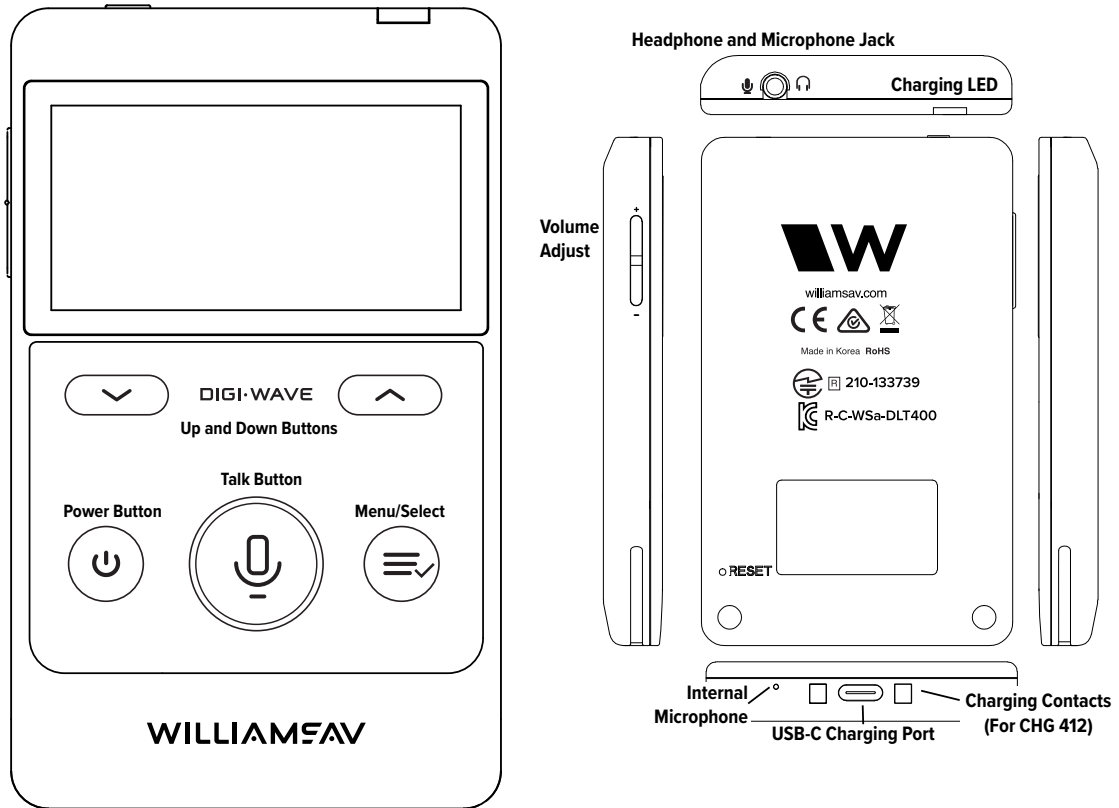

DLR 400 RCH Controls and Connectors

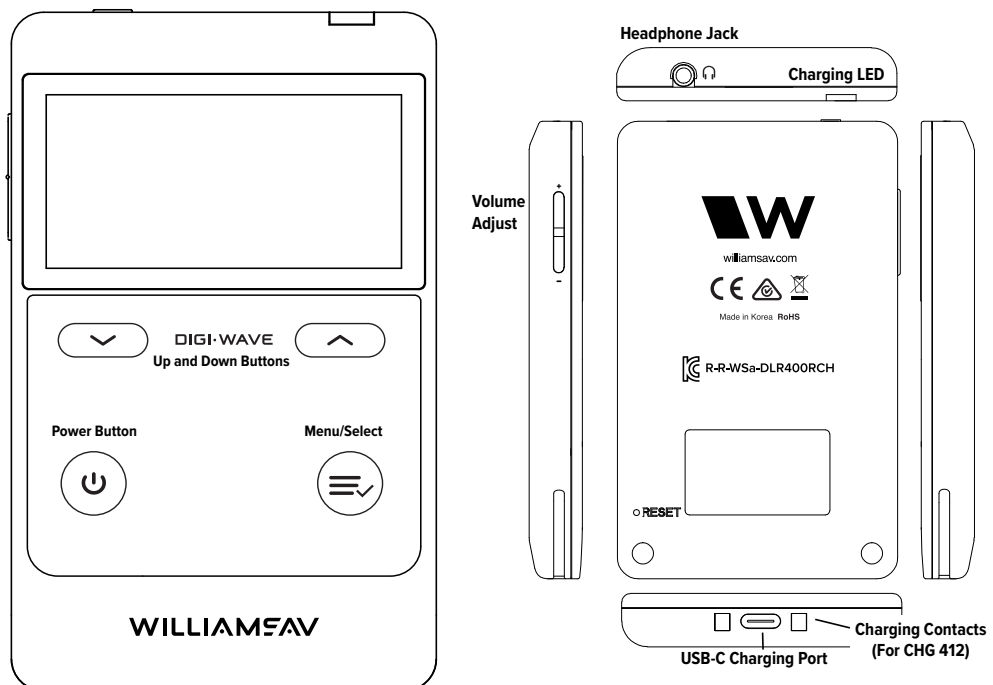

General Operation

Button Functions

Power Button

- Press and hold for power On/Off
- Press quickly to navigate back a step when using the menu.

Volume Control Buttons (on side)

- Adjust the headset's volume.

Talk Button

- The talk button will need to be used in order to talk or stop talking. There are two modes for the Talk button. For more details, see “Talk Mode: Push-to-Talk and Push-n-Latch (DLT Master 2 and Guest Only)” on page 13.
- This button is only on the DLT transceivers.
- Devices with a Master 1 or Master 2 Speaking Priority can override any speaking Guests by holding down talk button.

Menu/Select Button

- Press once while on the main screen to view additional Digi-Wave Information, such as firmware version.
- While on the main screen, hold the menu button down for a few seconds to enter the settings menu.
- While in the settings menu, press the menu button to select the highlighted option and move onto the next step.
- While in the settings menu, hold the menu button to exit the menu.

Up and Down Buttons

- Navigate through menu items.
- Adjust settings
- In Bilingual Mode, toggle which language is spoken.

Locking the DLT Buttons and Screen

Basic Lock

Lock enables the Administrator to prevent unauthorized changes to the system set-up by preventing the user from accessing the menu and using the up and down arrow buttons.

NOTE: Each DLT has to be locked and unlocked individually.

- To enable or disable the lock, hold down the volume up button and hold the menu button at the same time for 2 seconds. The lock icon will appear
- When lock is enabled, the menu system will have most features unavailable with a lock icon displayed next to it.



Super Lock

NOTE: The Super Lock feature is only available in firmware version 1.0.4 or higher.

Super Lock will ignore all button input until deactivated. While the basic lock prevents the settings menu from being accessed by a user who still needs to control the volume and other functions, super lock prevents unintended button presses from making any changes, such as when the device is in a pocket.

This mode can be enabled or disabled by holding down the **up and down arrow** buttons at the same time for about three seconds. A pop up stating the super lock was turned on or off will appear.

Battery Charging

Use the USB-C located on the bottom of DLT transceiver or the DLR 400 RCH Receiver, to charge the battery. Charge by either using a USB-C cable or using an approved, compatible Williams Sound charging station.

Full charging time is approximately 5 hours. The charging LED flashes red while charging. The charging LED will turn to a steady green light when the battery is charged.

NOTE: The DLR 400 ALK receiver uses alkaline batteries and is NOT rechargeable. Do not place these models in a charging station.

Additional information

- The DLT 400 transceiver uses an internal rechargeable Lithium Polymer battery.
- The DLR 400 **RCH** receiver is rechargeable and uses a Lithium Polymer battery. **Do not charge the DLR 400 ALK.**
- Charge the battery at room temperature.

CAUTION!

All lithium batteries have a limited number of charge/discharge cycles. Lithium batteries may experience swelling if used beyond their expected life cycle (~2 years with casual usage. Heavy usage will reduce the life cycle). If you notice swelling of the battery, please discontinue use and have the battery replaced. We recommend battery replacement after 2 years of use.

Before Programming the Digi-Wave™ System

Depending upon the mode chosen, up to six people can talk in a group at any given time. The Master 1 will have first priority, Master 2 has second priority and Guest units have third priority. When two or more people are talking in a group, the participants can hear their voices with the DLT transceivers or DLR receivers, but only those with a DLT transceiver have a microphone and can speak.

Modes

The Digi-Wave 400 system has been designed for ease and flexibility. Many of the settings are automatically configured for common use cases. These use cases are Tour Mode, Intercom Mode, Hearing Assistance Mode and Interpretation Mode.

While the modes are named by their most common usage, select the mode that fits your personal use case best. The mode is a just starting point; advanced settings can be adjusted to fit your situation.

Modes

Tour

Tour mode is best suited when one or two people are leading a large group. The group can be configured to only listen to the leader(s) of the group, such as on a museum tour. Alternatively, this mode allows people with a transceiver to speak, which may be useful for tours through noisy areas where hearing may be difficult, such as factory tours.

Intercom

Intercom mode is appropriate when a group of up to 6 people all need to talk to and hear one another. It may be used behind the stage to manage a large theater production, or for a security team at a club.

Hearing Assistance

Hearing Assistance mode is appropriate when using the device to amplify spoken communication between users. The Tone Control in Hearing Assistance mode is automatically elevated, allowing the user to hear more clearly. Users with transceivers can be allowed to speak, which may be useful in a classroom setting.

Interpretation

Interpretation mode is best suited when dealing with multiple, simultaneous audio feeds. In normal interpretation mode, an interpreter may be translating a speech given in Spanish into English, a group of interpreters may be translating a speech in English into several languages. Up to 14 languages and the floor may be broadcast on the Digi-Wave system at one time.

Court

Court mode allows toggling between secured groups, without letting the Guest unit on an unused or incorrect Group. A Guest unit can access up to four pre-selected groups, but nothing else. Although this mode is named Court Mode, this mode can be used whenever a limitation to group selection is needed.

Interpretation Mode: Broadcast Type

When in Interpretation Mode, you will be required to select a broadcast type. The broadcast type helps determine which channel the DLT transceiver will broadcast on.

Floor will broadcast on channel 0. This is intended to be the main audio for the event that is being interpreted.

Interpreter will broadcast on channel 1 - 14 depending on what is available. Each channel is able to be used by a dedicated interpreter. All interpreter units can hear the Floor on channel 0, and transmit the Interpreter's voice on channels 1 - 14. At any time, by changing channels, anyone can listen to the Floor on Ch. 0 or any Interpreter on channels 1 - 14. The interpretation is broadcast 1-way in up to 14 languages.

Repeater is used to extend the range of the Digi-Wave 400 system by up to 50%. The repeater will broadcast on one channel, depending on which channel(s) needs to be extended. This mode does not require a person to be speaking or listening to the transceiver.

For more information on additional features of Interpretation Mode, see "Interpretation Mode Features" on page 15.

Speaking Priority

There are 3 levels of priority.

- Master 1 has first priority, and also sets up a majority of the settings for the Digi-Wave system. **There can be only one Master 1 unit per group.**
- Master 2 has second priority when speaking, but does not declare any settings for the Digi-Wave system, only for their personal device. **This is not available in Interpretation mode.**
- Guest units have third priority, and can only declare settings for their personal devices.

The Master 1 and Master 2 have the ability to lock out other talkers by holding down the Talk button for three seconds. All system Talk LEDs will continuously flash while other participants are locked out of the Talk feature. The Master 1 can override anyone else talking within the group. Master 2 has talking priority over Guests.

The Master 1 or Master 2 must have their talk button deactivated to allow the Guest units to talk. When 2-6 people are talking in a group, the participants can hear their voices in the DLT transceivers or DLR receivers. DLR receivers can only listen, as they do not have a microphone or talk button.

If a Master 1 unit leaves the conversation, the other devices in the group cannot continue the conversation without them. A Master 1 must be present for the Digi-Wave system to be used.

Groups and Channels

Depending on the Mode you select, you will primarily be working with Groups or Channels. Both settings determine who hears the audio, and are very similar in concept.

Groups are used in every mode. A group is a selection of people communicating with one another. For instance, there may be one tour group for a basic tour and another tour group for a VIP tour. Both these groups may be in the same area, but their audio will not overlap since they are in different groups.

Channels are used in Interpretation mode. Users configure their device to listen to a certain channel based on what they need to hear. For instance, in Interpretation mode, there may be a channel per language. Users will listen to the channel for the language they speak, and not hear the audio for languages they do not understand.

In a theatre with two showrooms, the Digi-Wave system may have a group for each theater. Each group may have up to 15 channels of audio in use. Each user will need to be assigned the correct group for the theater they are sitting in, as well as the correct channel for the appropriate audio.

Addresses

Addresses are unique numbers given to each Digi-Wave transceiver in a set up. Typically, addresses will be automatically assigned but in some use cases, manual assignment may be necessary. If manually assigning addresses, make sure each address is unique; addresses between 0 and 1023 can be selected. Each of the 1024 addresses is available per group.

DLR receivers do not have addresses.

Selecting Group(s) and Channel(s)

Each set of people who want to talk and/or listen to each other must be in the same group. Up to 4 Groups can operate simultaneously within range of each other. Up to 15 channels can be used simultaneously.

Group numbers and channels are selected via the settings menu. Pressing the up or down button will allow you to manually select the group or channel number.

Profiles

Configurations of settings can be saved to a Profile to be easily reloaded later. A profile may be created on any device and loaded later. Profiles are useful when Digi-Wave devices are used in multiple ways, such as being used for both Tours and Hearing Assistance.

General Rules of Operation

The following rules must be followed. Failure to adhere to these rules will result in unpredictable, unsupported operation.

- There must be only one Master 1 per group.
- Master 2 is optional, and there can only be one per group.
- Any other DLT 400 units must be a Guest unit.
- Each DLT transceiver must have its own address and the address cannot be duplicated within a group.
- Each group must be assigned its own group number. Williams AV recommends a maximum of four groups using the system simultaneously within the same area to prevent interference.
- When using four simultaneous groups, group numbers must be sequential. i.e. 11, 12, 13, 14. Any numbers 0-1023 can be used (only 0-99 if DLR 360 or DLT 400 ALK receivers are being used).

The Main Screen

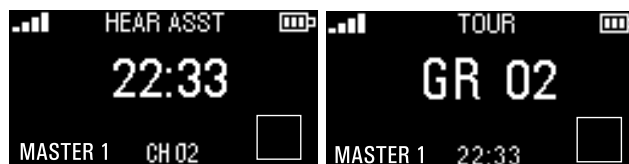

Display Settings

The mode will be displayed at the top of the screen, between the signal strength indicator and the battery level indicator.

Depending on your setting selections, the clock, the channel or the group will be displayed in the center of the screen. Channel or Group is determined by your mode. A large or small clock is determined by the Master 1 settings.

To change any of these settings, hold down the menu button. For instructions on configuring the Digi-Wave system, see “Basic Settings” on page 11.

Signal Strength Indicator

When a Master 1 is available on the group or channel, the signal strength indicator on DLR Receivers and Guests will indicate how strong the signal is.

When a Master 1 is not available **OR** while the Master 1 is changing settings that may affect other devices, the icon will disappear. Once the Master 1 has been set up, the DLR Receiver and other DLT transceivers should rejoin the group or channel automatically (with some exceptions, such as a Security PIN being set).

Attendee Checking

The number of DLT transceivers currently talking will be displayed in the bottom right corner box. It does not count DLR Receivers because they do not have a talk button.

Priority Indicator

A label indicating Master 1, Master 2 or Guest will appear on the lower left of the screen on the main screen.

If the label is blinking, the device has not had its settings configured. Enter the menu system to begin configuring the device.

Setting Up the Digi-Wave™ System

Settings of the Digi-Wave system should be selected based on how the system will be used. A Master 1 device will declare a majority of the settings and pass these settings to devices that connect with it. Since the Master 1 automatically sets most settings, there is little to be set up on Guest devices for basic usage of the Digi-Wave system.

For more information on terminology and a general system overview, see “Before Programming the Digi-Wave™ System” on page 7.

Language

The Digi-Wave menu is available in multiple languages. Select the language you desire for set up.

Initial Setup



When a DLR Receiver or a DLT transceiver is first started, some settings will need to be selected before the device can be used. There are three ways to load settings on a Digi-Wave device:

New Settings

To start from the very beginning with your Digi-Wave settings, select New Settings. This will start you at the beginning of the set-up process where you can set Basic Settings (see “Basic Settings” on page 11).

Load Profile

To load an existing profile on the device, select this option and then select the profile to load. You may either load a profile as it is, or adjust the settings once it is loaded (see “Basic Settings” on page 11).

Join Group

If a Master 1 is already leading a Group or Channel, Digi-Wave 400 transceivers and receivers can automatically search for the group and join it. The list of available groups will be in the order the device detects them, which may not be in numerical order.

The group or channel number could also be manually entered from this screen. Settings will be loaded from the Master 1 device, once a connection is established.

If a group or channel is locked by a PIN, the device will prompt for the PIN at this time. The device will be unable to join the group or channel without this PIN.

For interpretation mode, a Master device should not use this feature. They will be unable to select the channel they desire. Please configure the device using the normal setup menu. Guest units can use the Join Group function normally.

When using this feature to join a group, Addresses will be automatically set. If you need manual addresses, the DLT 400 will need to be set up using a profile or through setting up New Settings.

If the group should not be able to be automatically joined, this feature can be disabled by the Master 1 device for specific groups. See “Allow Join Group” on page 15 for more information.

Changing Settings

If settings need to be adjusted later, the menu system can be reentered at any time by holding down the menu button for a few seconds. From there, settings can be edited by selecting **New Settings**. You may also load a profile or join a group or channel.

The menu system can be exited at any time by holding the menu button. Any uncustomized settings will be set to their default.

To go back to a previous setting while in setup mode, press the **Power** button.

Basic Settings

Always start setting the Digi-Wave settings with the DLT transceiver that will be the Master 1. Other devices can gather their settings from the Master 1 device to ease setup. DLR Receivers and other DLT transceivers that are not Master 1 may still need their settings adjusted, but they should still be set up after the Master 1.

1. Select a Mode. This determines what other settings may be available. See “Modes” on page 7 for more details on the various modes.
2. Select Speaking Priority. If this is the first DLT transceiver you are setting up, you will want to select Master 1. Typically, all other units will be Guest priority. See “Speaking Priority” on page 8 for more details on the various speaking priorities.
3. Select the group number. Holding down the up or down button will seek for available groups/channels. Pressing the up or down button will allow you to manually select the group or channel number. For more information on groups, see “Groups and Channels” on page 8.
4. If in Interpretation Mode, set the Broadcast Type (see “Advanced Settings” on page 11).
5. The Master 1 can select a handful of options that will affect the main display on other devices:
 - Select whether to display clock or hide it entirely.
 - Select the clocks location, if displayed.
 - Select whether the clock is a 24-hour or 12-hour clock.
 - Set Master 1 manual address. (Guests and other device can set the address under Advanced Settings.)
Automatic address selection is recommended unless there is a need to override the address.
6. Enter Advanced Settings (See “Advanced Settings” on page 11) if more customization is needed, otherwise the device is ready to be used.

Advanced Settings

Advanced Settings are usually available regardless of the mode selected, but some Advanced Settings may be missing from certain modes, or with certain configurations.

Number of Microphones (DLT 400 only)

In modes where multiple speakers are available, the number of speakers at one time can be limited. The maximum number of speakers is 6, the minimum is 2 when this option is available. The number of microphones is not limited by the selected mode (except for in Interpretation Mode, which assumes one speaker per channel). Users with DLR Receivers do not have microphones or talk buttons and cannot be speakers in any circumstance.

Only 4 speakers using DLT 300 transceivers are allowed. 6 speakers can still be in the group, but the 5th and 6th speakers must be using DLT 400 transceivers.

Example - Tour System

The system has been configured so that up to four people can have open microphones and be talking at the same time. One DLT is set up as a Master 1 unit for the tour guide. Each tour member has a DLT transceiver set up as a Guest unit.

When a 5th person desires to speak, they push their talk button. This deactivates the talk button of the first Guest that turned their microphone on. This First-In-First-Out speaking priority continues each time a member pushes their talk button who is not a part of the speaking group.

If the group speaking needs the 5th person to be able to speak, they can adjust their device settings to allow 5 speakers.

The Master 1 or Master 2 Tour Guide has the ability to take control of the discussion by overriding Guest units, if needed. This is accomplished by pushing-and-holding their talk button down for a few seconds which mutes all Guest unit microphones. When overriding, the talk button will blink red.

A second Tour Guide may be added as a Master 2 unit, which takes priority over Guest units. Master 1 and 2 units have two-way communication capability; they can talk/listen simultaneously to one another.

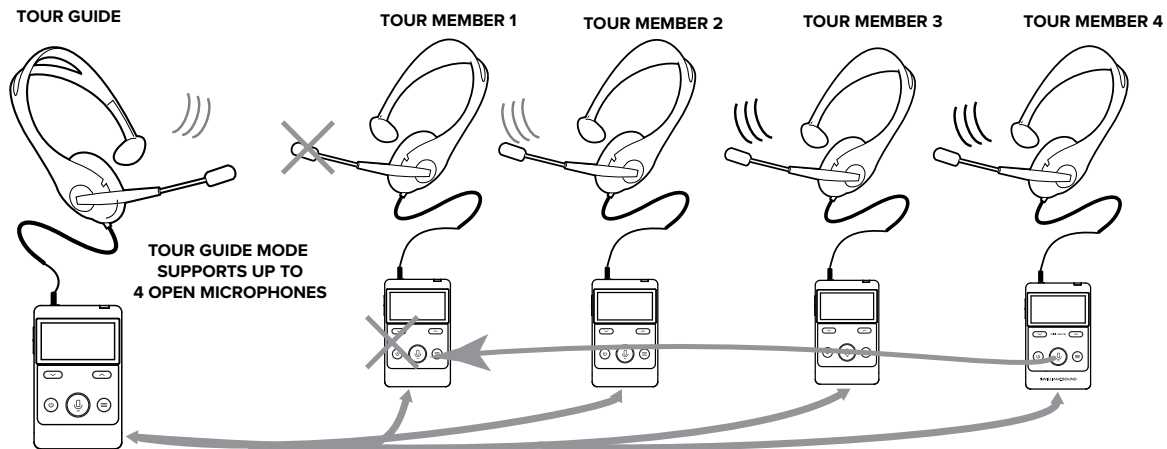

**TOUR MEMBER 4 (THE 5th UNIT) CAN LISTEN TO THE GROUP -OR- CAN TALK BY PUSHING TALK BUTTON AND KNOCKING TOUR MEMBER 1 OFF
-BUT- ONLY 4 PEOPLE CAN TALK AT THE SAME TIME (4 OPEN MICROPHONES MAX)**

Example - Intercom

One DLT transceiver is set up as a Master 1 unit. All other DLT transceivers are programmed as a Guest unit. Up to six people can have open microphones and be talking at the same time. When a 7th person desires to speak, they push their talk button. This deactivates the talk button of the first Guest that turned their mic on. This First-In-First-Out order continues each time a member pushes their Talk button who is not a part of the speaking group.

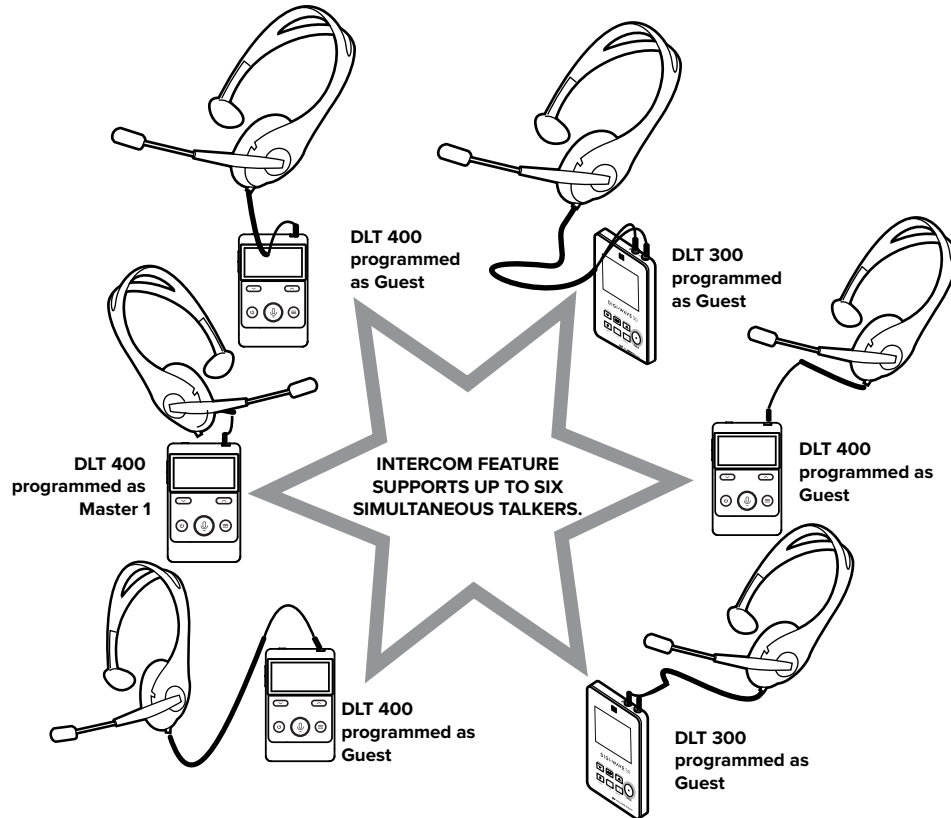

Talk Mode: Push-to-Talk and Push-n-Latch (DLT Master 2 and Guest Only)

On a DLT transceiver, the **Master 2 or Guest** Talk Mode can be changed to Push and Latch or Push to Talk. Master 1 DLT transceivers are always set to Push-N-Latch mode. This feature is not available on a DLR Receiver as it does not have a microphone or talk button.

In **Push-n-Latch** mode, when the talk button is pressed and released, it stays in talk mode until the talk button is pressed and released again.

In **Push-to-Talk** mode (the default mode), the talk button must be held down while speaking, and when released, it shuts off.

Tone Control

The default for tone control is 5, unless in Hearing Assistance mode, where the default is 9.

Using the up and down arrow buttons, adjust the tone up or down to your preference. The number range indicates:

- 1 = Most bass response
- 5 = Flat
- 9 = Most treble response

Side Tone Adjustment

This gives the user the ability to change the volume of their own voice as heard in the headset (side tone). This feature is only available on the DLT transceiver.

Use the up and down arrow buttons to choose between off (0 dB), low (-12 dB), or high (-6 dB).

Microphone Gain, Line Input Gain and Line Output Gain

Gain can be used to increase the volume of the microphone or line input sound. Line input is connected via a USB-C connector.

Use the up and down arrows to adjust the gain to a suitable level. The default value for the microphone gain is 33. The default value for the line input gain is 5. The default value for line output gain is 0, but can be adjusted to +4dB.

Note: For setting up an input line interface, please contact TechBlue Technical Support.

Display Clock

The clock can be displayed in several formats on the main screen. It can be shut Off, displayed Big in the center of the screen, or displayed Small near the bottom of the screen (default behavior).

The group or channel will be displayed at the bottom of the screen in small font if the clock is set to display big. The group or channel will be displayed in the center of the screen if the clock is set to off or small.

Manual Group and Address

If the Group or Address needs to be adjusted, it can be set here. This may be necessary if needed to be backwards compatible with the DLT 300 or DLR 360 from the previous generation.

Encryption

Extra security can be added to the transmitted signal via encryption. The “**300 Compatible**” 87-bit encryption is default. This level of encryption is backwards compatible with the DLT 300 from the previous generation. The DLR 360 cannot work with encrypted signals.

128 + 87-bit Encryption adds AES-128 encryption on top of the 87-bit encryption. This adds an additional layer of security, but is not backwards compatible and may only be used with Digi-Wave 400 devices. This method requires an Encryption PIN.

Encryption PIN:

When a group or channel has been set up with a Encryption PIN, master and guest transceivers and DLR 400 receivers without this Encryption PIN entered cannot listen in on the group. This may be desirable in private or high security-level functions. **The PIN cannot be used with DLR 400 ALK units.**

The same four digit code must be programmed into all of the Digi-Wave devices in the group. If a different secure code has been entered, participants cannot re-enter the group without re-entering the correct secure code. The only time the Encryption PIN is displayed is when it is being entered. As the PIN is being entered, individual numbers will be replaced by the * symbol.

We recommend using a unique PIN to your group. Using PIN 0000 or other easily entered or guessed PIN will not be as effective as a unique pin.

To set the PIN:

1. Select whether or not the connection requires a PIN. If yes, you will be prompted to enter the desired PIN.
2. Choose a 4 digit numerical code; i.e. 4297. You must use the same code on each device in the group.
3. Using the up and down arrows, enter first digit of the code (0 – 9).
4. Press the menu/select button to move to the second digit. Enter the next digit and continue until all four digits have been entered.

When setting up the other transceivers or receivers for this group or channel, enter the same code into those devices.

When the Encryption PIN is set, a key icon will show on the main screen under the signal strength indicator.



To remove an Encryption PIN when using 300 Compatible mode (Pins are required in 128+87 mode):

1. Go through the menu system until you are prompted if you would like to use a PIN code.
2. Select "NO PIN CODE." The existing PIN will be removed.

Allow Join Group

The Master 1 can prevent other devices from seeing the group as available to join. Disabling Join Group will prevent available groups from being listed under the Join Group menu. Devices will have to be manually set to the correct group or channel.

See "Join Group" on page 10 for more details on the Join Group feature.

Factory Reset

If the Digi-Wave device is not behaving correctly, or otherwise needs to be reset, a factory reset option is available. This is the last item in the Advanced Settings menu. If the device is reset, all changes selected before this reset will be lost.

The factory reset can also be done manually. A hole is on the back of the device. The hole covers a switch that can only be reached with a paper clip or other thin material. Pressing the button with the paper clip while the device is on will display a prompt on the screen asking to perform a factory reset. Select Yes to reset the device.

Interpretation Mode Features

Interpretation Mode has several features not available in other Digi-Wave modes.

During setup, you will be prompted to select a broadcast mode and select an additional interpretation mode. The available options for broadcast mode are Floor, Interpreter and Repeater. The available options for the additional interpretation mode are Standard, Bilingual and Relay.

Floor and Interpreter

The floor is the main speaker or audio of the event. In a lecture, this is the person standing at the podium. Interpreters translate the audio from the floor into another language. There can only be one floor in a Digi-Wave system, but there can be up to 14 interpreters.

The floor will always broadcast their audio on channel 0. Interpreters can broadcast their audio on channels 1-14. Interpreters can listen to channel 0 as they interpret in standard interpretation mode.

Repeater Broadcast Mode

Repeater mode can be entered by selecting it as the Broadcast Type during setup.

An additional DLT 400 can be set-up as a repeater to increase the range of each channel.

When repeater mode is used, the Repeater is configured as the Master 1, and all units sync to this Master Repeater. The floor unit should be configured as a guest.

There can only be one repeater per channel and one of the repeaters must be a Master unit. In basic scenarios, it is best to set the Repeater on Channel 1 since most connecting devices can easily access this channel.

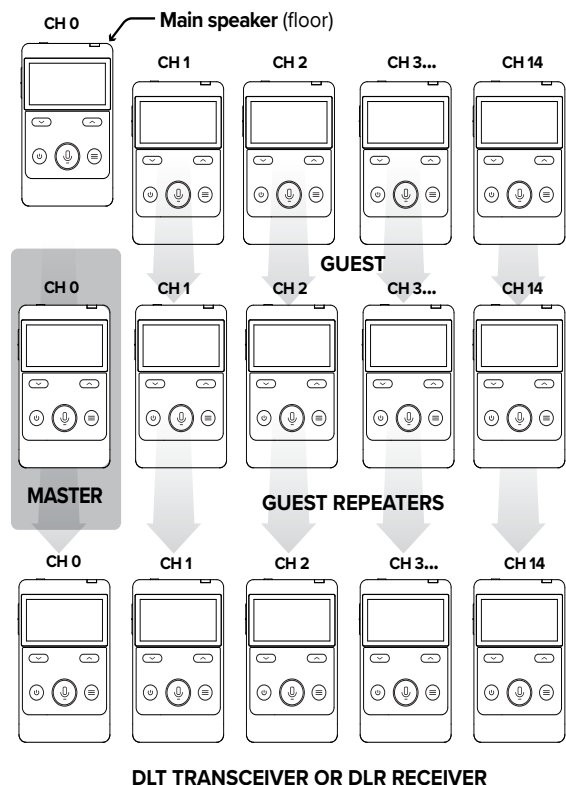

Standard Interpretation Mode

Standard interpretation mode allows for each DLT transceiver to listen to the floor (the main speaker) on channel 0 and broadcast out in one interpreted language on a channel (1-14). Each additional channel or language requires their own DLT transceiver and interpreter. The audience member then listens to the channel for their specific language.

Note: In previous Digi-Wave versions, this was known as Simultaneous Interpretation Mode.

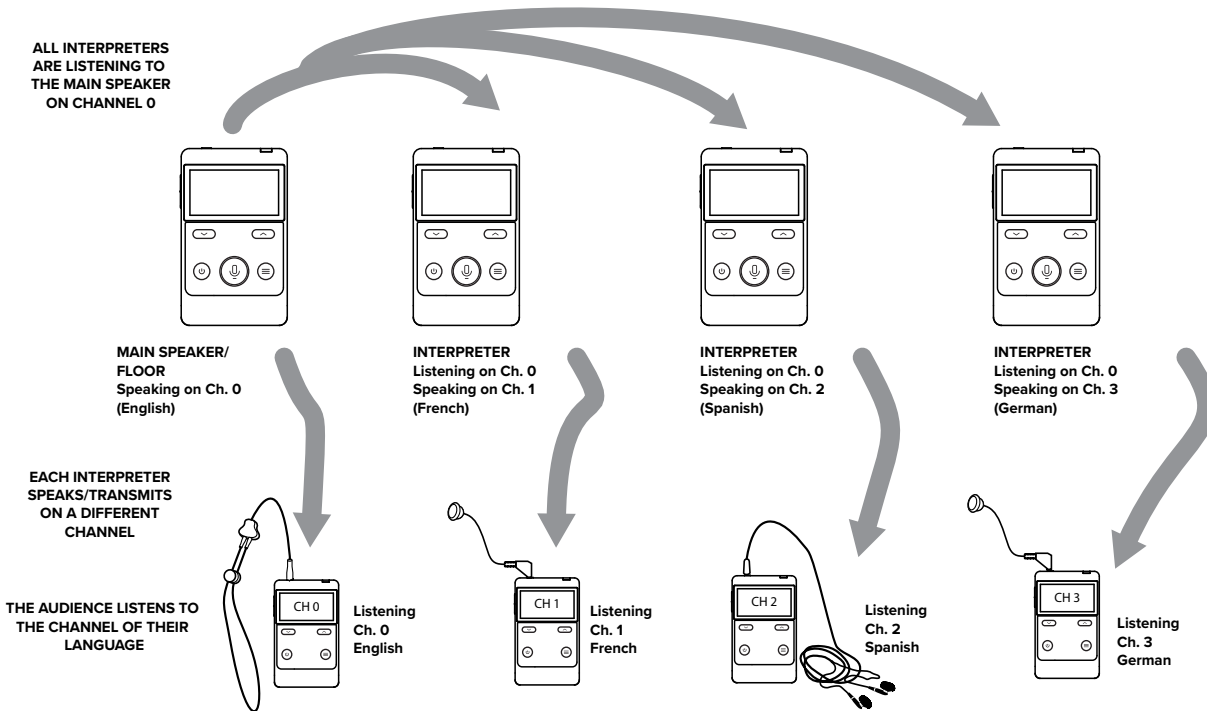

Bilingual Mode



Bilingual mode allows the interpreter to quickly switch their output channel between Ch. 1 or Ch. 2, depending on which language the audience needs to hear.

This mode eliminates the need for the interpreter to physically switch between 2 DLT transceivers programmed to fixed channels. The interpreter can easily switch between which channel is being broadcast by using the up or down arrow under each channel listed.

For example, the Floor changes from a Japanese speaker to an English speaker. When the Floor is speaking Japanese, the bilingual interpreter selects Ch. 1 as the output channel and interprets Japanese to English to the English audience. When the Floor changes to a English speaker, the interpreter selects Ch. 2 as the output channel and interprets English to Japanese to the Japanese audience.

The DLT transceiver in Bilingual Mode always listens to channel 0, regardless if channel 1 or 2 is chosen as the transmission channel. Only one DLT transceiver can be programmed to transmit on channels 1 and 2.

The bilingual interpretation mode may be utilized within a larger system. For example, one interpreter can use the bilingual mode on channel 1 and 2, while others have the normal mode on other channels. It does not work with Relay Mode.

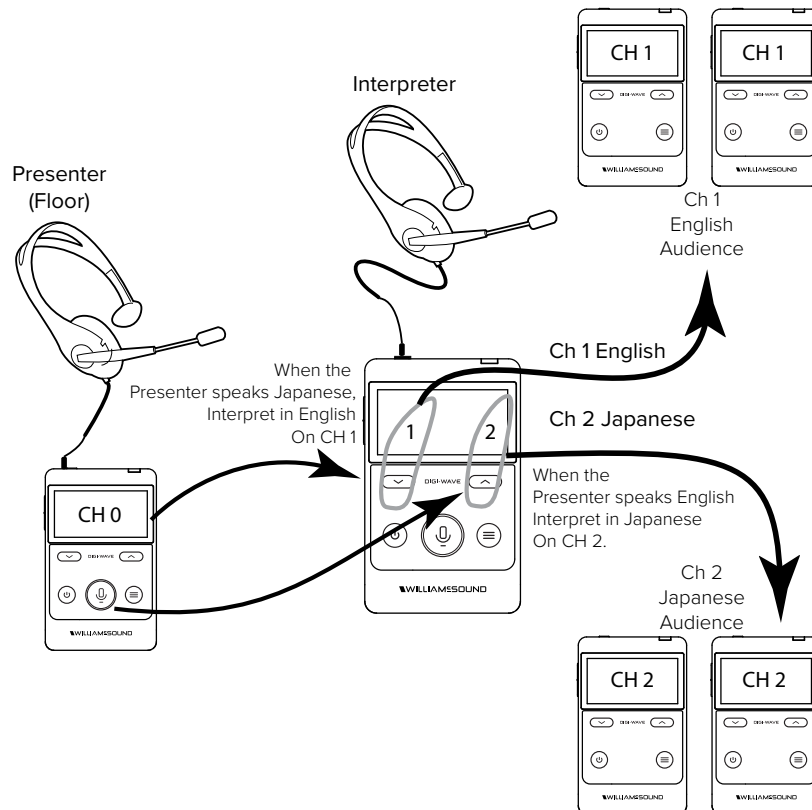

Relay Mode

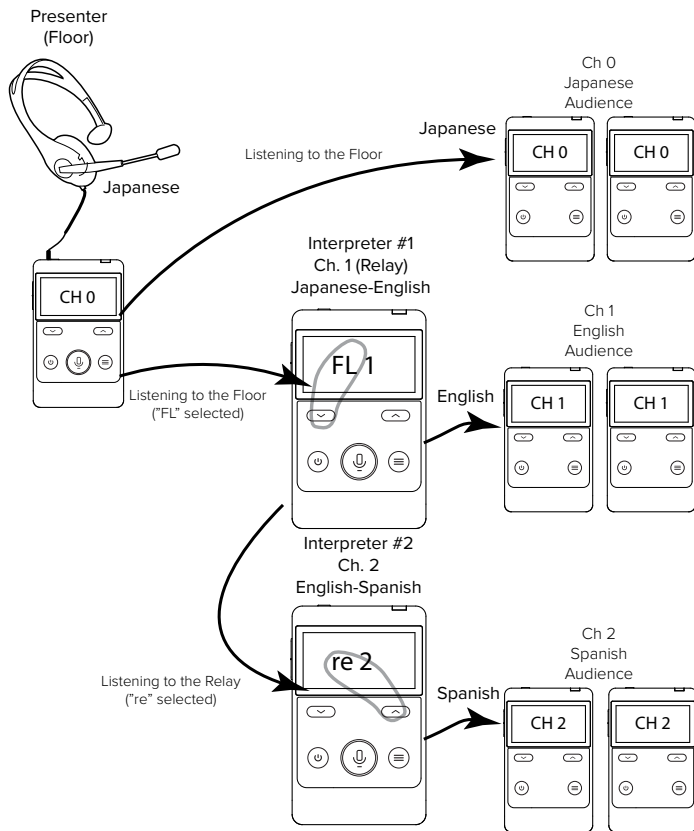

Relay Mode allows the interpreter to quickly switch between listening to the Floor on Channel 0 or the Relay on Channel 1.

For example, the floor is speaking Japanese. The Japanese audience can listen to the Floor on Ch. 0. Interpreter 1 pushes the down button to hear the floor, and interprets Japanese to English to the audience listening on Ch. 1. Interpreter 2 speaks English and Spanish, and cannot translate from the floor as they do not speak Japanese; they need to listen to Interpreter 1's translation as a relay. Interpreter 2 listens to the relay (Interpreter 1) by pushing the up button and interprets English to Spanish to the audience listening on Ch. 2.

Channel 1 is automatically the Relay channel. Channel 1 will automatically listen to Channel 0, just as in Standard Interpretation Mode. The DLT transceiver transmitting on Channel 1 cannot switch and listening to Channel 1, and the floor cannot listen to channel 1. Interpreters on other channels (2-14) are able to switch which channel they are listening to.

Only one DLT can be programmed to transmit on each channel. All interpreter units must be programmed in the Interpretation with Relay Mode, and cannot be combined with units programmed in other modes.

Note: Bilingual Interpretation is unavailable in Relay Mode.

Court Mode

Court mode may require a firmware update to version 1.2.0 or higher to be available on your Digi-Wave devices.

Court mode is used to limit users to specific groups. When not in court mode, a guest Digi-Wave unit can change their group to any group. In Court Mode, the guest unit can only access up to four pre-selected groups.

Limiting the access to groups may be useful in situations requiring privacy and security, such as in a court. For example, a lawyer may need to privately consult with their client on Group 12, and may also need to listen to the judge on Group 10. To prevent the lawyer from accidentally broadcasting private case information on any other Group, the lawyer would be limited to only accessing Groups 10 and 12.

PIN codes can be assigned to a Group to further secure access to a group. Court mode has the added benefit of quickly toggling between groups, even if they require a PIN code, without letting the Guest unit end up on an unused or incorrect Group.

Although this mode is named Court Mode, this mode can be used whenever a limitation to group selection is needed.

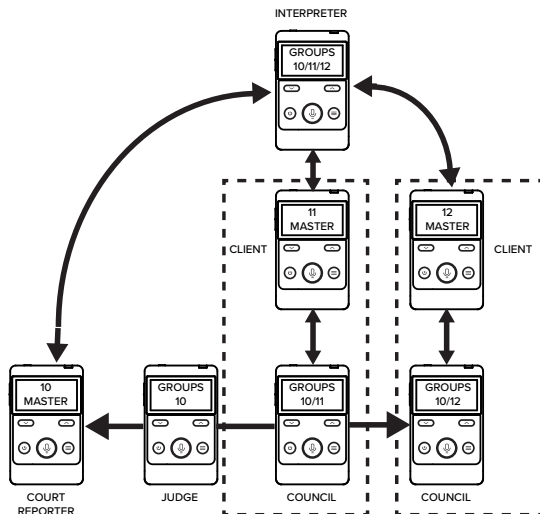

Device Availability

Court Mode is only available for DLT 400 transceivers and DLR 400 RCH receivers. It is not available for DLR 400 ALK units or for backwards compatibility with the Digi-Wave 300 Series.

For older Digi-Wave 400 series units, a firmware update may be required to use Court Mode.

Group Selection

A Master unit can only be in one group and cannot toggle between groups. Like most other modes, the Master unit will be programmed with the settings for one specific group.

Guest units can access up to four groups. The Guest will be able to add up to four groups. If a PIN code has been set up for the group, the Guest will be required to enter it when they add the group. PIN codes are only available in with Encrypted signal transmission.

Both the Master and any Guest devices must be set to either encrypted or unencrypted signal transmission.

Once the setting for Court Mode have been saved on a Guest device, any Group previously accessible by the unit will be erased from the device. All groups the Guest unit should be allowed access to will need to be entered at once. A single group cannot be added or removed later.

Toggling Between Groups

Once setup is complete, the Guest unit can use the Up and Down buttons to toggle between the list of groups on the left hand side of the screen.

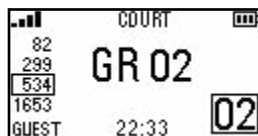

The Guest indicator will flash until the group is joined. If a device seems unable to join a group, check the PIN code.

Locking the Device

To prevent Guest units from accessing the setup menu, using Basic Lock is recommended. Basic lock can be activated by holding the volume up button and menu button at the same time for a few seconds.

Guest units can still edit some personal auto settings by repeatedly pressing (not holding) the menu button. These settings include viewing the System Information, and Adjusting Mic Gain, Side tone, and Tone. Volume is adjustable using the volume up and volume down buttons.

Microphone Mute

Court mode requires Push-n-Latch mode. Push-to-Talk mode is not available in Court mode. To mute your microphone, press the Talk button so the red light around the Talk button is no longer on.

Holding down the talk button will not mute all speakers in court mode.

Saving and Replacing Profiles

After settings have been configured, you will have the option to save your settings as a profile, or replace an existing profile. This is only available if Advanced Settings have been adjusted.

If you choose to not save your profile, the device will still use the settings but they cannot be loaded again if the settings are later changed.

Saving Profiles

After selecting your settings, you can select a numbered profile where you can save your settings. Five profiles are available.

Profiles that are being used have a disc icon next to them. Profiles can be overwritten if desired.

Select the profile name to use to save the settings to the profile. If the profile is already in use, confirm that you are replacing an existing profile.

Loading Profiles

For information on loading profiles, see “Load Profile” on page 10.

Differences between DLT 400, DLT 300, DLT 100 2.0 & DLT 100

Function/ Description	DLT 400	DLT 300	DLT 100 2.0	DLT 100
Lock Mode	Most settings unavailable when lock set. Lock icon next to unavailable settings.	With settings locked, can ONLY adjust Power, Volume, Talk	With settings locked, can ONLY adjust Power, Volume, Talk	With settings locked, can adjust Power, Volume, Talk, Tone, Mic level, and Group
Voting function	Not Available	Not Available	Not Available	Available
GRP button / ABS button	Not Available	Labelled “GRP” 1-way mode: not functional 2-way mode: used to enable easy group change with push-and-hold of this button	Labelled “GRP” 1-way mode: not functional 2-way mode: used to enable easy group change with push-and-hold of this button	Labelled “ABS” 1-way mode: not functional 2-way mode: On Master, used to enable voting; on Master 2 or Guest, used to “Abstain” when voting
^ button / yes “ch+” button	Labelled ^ Navigates menu system Channel/Group up	Labelled ^ 1-way mode: Channel up 2-way mode: Group up	Labelled ^ 1-way mode: Channel up 2-way mode: Group up	Labelled yes 1-way mode: Channel up 2-way mode: Group up
v button / no ch-button	Labelled ^ Navigates menu system Channel/Group down	Labelled v 1-way mode: Channel down 2-way mode: Group down	Labelled v 1-way mode: Channel down 2-way mode: Group down	Labelled “no” 1-way mode: Channel down 2-way mode: Group down
Listen only (1-way mode)	Not Available	Available	Available on F-8 firmware Not available on F-7 firmware	Available
Speaker only (2-way mode)	Not Available	Available	Available on F-8 firmware Not available on F-7 firmware	Available
Group Number / Clock function	Can switch positions. One may be displayed in the center of the screen, the other small near the bottom.	Icon GROUP and Group Number Displayed in place of Clock on Main Screen	Icon GROUP and Group Number Displayed in place of Clock on Main Screen	Clock Enabled on Main Screen and during Master 1 Setup
Talk Timer function	Not available.	Not Available; Group number displayed in place of Talk Timer on Main Screen	Not Available; Group number displayed in place of Talk Timer on Main Screen	Available

Function/ Description	DLT 400	DLT 300	DLT 100 2.0	DLT 100
Push-to-Talk and Push-and-latch functions	Available on Guest units only	Available on Guest units only	Available on Guest units only	Not Available
Microphone Gain Max Level	53	53	53	63
Side Tone Adjustment	St: Off, low = -12 dB, high = -6 dB	St: 0=off, St: 1=-6 dB, St: 2=-12 dB	St: 0=off, St: 1=-6 dB, St: 2=-12 dB	Not Available
Dock detected/Mic Disable	Available with adapter	Available; The DLT 100 2.0 is compatible with a dock.	Available; The DLT 100 2.0 is compatible with a dock.	Not available. The DLT 100 is not compatible with a dock.
Auto shutoff timing for Guest Units	5 min.	5 min. (Same as DLR 360)	5 min. (Same as DLR 60 2.0)	2 min.
Line Input or Output Level Adjust	Available in Menu System	Available with push-and-hold of “^” button; eight levels L:0 through L:7	Available with push-and-hold of “^” button; eight levels L:0 through L:7	Not Available
Compatible with Digi-Wave Dock	Available with adapter	Yes	Yes	No

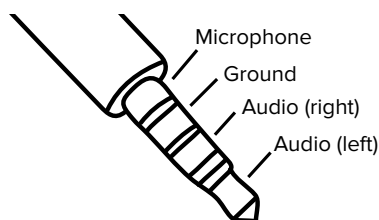

Microphone/Headset Jack Difference

The jack on the Digi-Wave 400 series is different than older devices. The wiring diagram in this section explains the internal wiring. See the pinout diagram for details.

Differences Between Historical Digi-Wave DLTs

This chart covers feature *differences* only, not features common to all DLTs, based off the most common firmware versions. The features available are shown in the chart below. If blank, the feature is not available.

Description	DLT 400	DLT 300	DLT 100 2.0	DLT 100
Quick Group Change	✓	✓	✓	
Voting Function				✓
Receive Only (1-way mode)		✓	✓	✓
Speaker Only (2-way mode)		✓	✓	✓
Clock or Group displayed on Main Screen	Optional Clock	Optional Clock or Group	Clock	Clock
Talk Timer				✓
Auto Shut-off	5 minutes	5 minutes	5 minutes	2 minutes
Push-to-Talk & Push-and-Latch	✓ (Guest units only)	✓ (Guest units only)	✓ (Guest units only)	
Mic Gain Default Level	33	33	33	36
Mic Gain Max Level	53	53	53	63
Digi-Wave Dock compatible	With Adapter	✓	✓	
Up to 2 Active Mics	✓	not limited to 2 in tour mode	✓	✓
Up to 4 Active Mics	✓	Tour Guide Mode		
Up to 6 Active Mics	✓	Intercom Mode		

Updating DLT 400 and DLR 400 RCH Firmware

The Digi-Wave system should ship with the latest firmware; however, over time systems may need to be updated.

A Downloader will need to be installed onto a computer in order to load the firmware onto the Digi-Wave device. The Downloader is a separate software download from the Digi-Wave firmware itself.

The latest firmware and the Downloader can be found on the Williams AV website, linked to on the product's page.

To prepare the Downloader software:

1. Download the Downloader, and run the program.
2. If the USB drivers are not installed, click the **Install dll and USB drv** button.
3. The drivers will install, and a pop up message will let you know the installation is complete.
4. Once the drivers are installed, the button will no longer be active.

To update your DLT 400 and DLR 400 RCH device:

1. Download the firmware .bin file off of the Williams AV website to your computer.
2. Turn the device you are updating off.
3. Hold down the **menu/select button**.
4. While holding down the menu/select button, connect a USB-C cable to the device, similar to if you were charging the device.
5. After a few seconds, **Download Mode...** should appear on the device's screen.
6. Release the **menu/select button**.
7. Open the **Downloader**.
8. Select the COM port the device is connected to.
9. Press the **Find File** button and select the firmware file.
10. Click the **Download button**.
11. The device will be ready to use when the update is complete. A blue message will appear if the installation was successful.
12. Once the firmware installation was successful, disconnect the USB cable.
13. Power on the device. The firmware version displayed when starting should be updated.

Note: If the DLR 400 ALK requires updates, please contact our TechBlue Technical Support team.

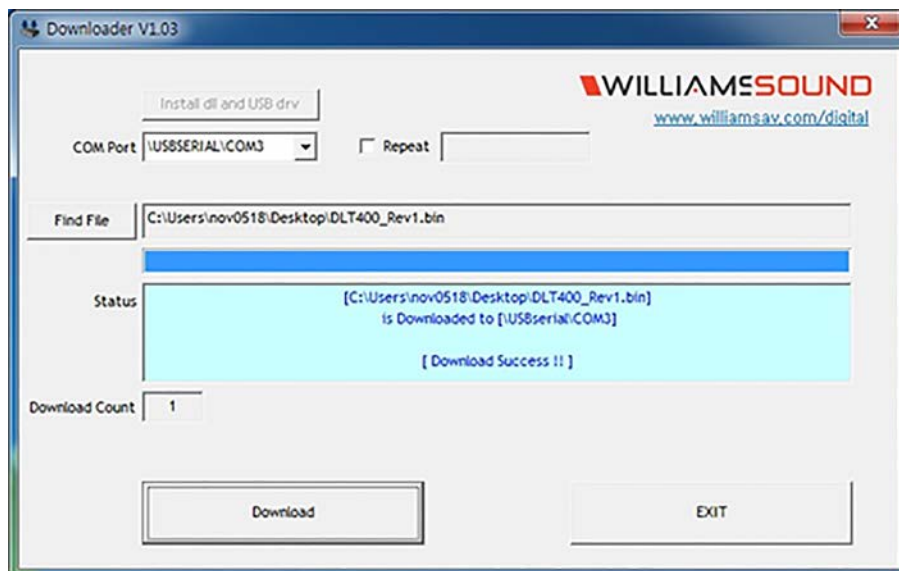

Troubleshooting

Problem	Cause	What to Do
Power does not turn-on	Dead battery	Charge the battery, replace battery
Power turned off automatically	Master device can't be found	Turn on Master unit
Power doesn't turn off	Program Error	Press reset button on the back of device (DLT only)
No audio or wrong audio in headphones	Disconnection of headphone	Check headphone connection
	Master unit shut off	Turn on / set Master
	Different Group Number settings	Set every unit to the same group number
	Out of range	Move to within the range of 100ft (outside) or 200 ft (inside) from the Master unit
	More than 1 Master exists in a group	Set one Master per group
	Obstacle exists	Move to another place or move the obstacles
	More than 2 units with same address exist in a group	Set different address
Error in attendee checking	More than 2 units with same address exist in a group	Set different address
Can't select receiving channel	Transmitting channel is overlapping	Set different transmitting channel
Can't select group/channel on receiver	Receiver is locked	See "DLT Lock" on page 6
Unable to transmit Interpretation	Check the mode for simultaneous interpretation mode	Set simultaneous interpretation mode
	More than 2 Master units exist	Set one Master only
DLT keeps turning off	Master unit shut off	Turn on / set Master
Can't hear the speaker	Mic Sensitivity too low	Adjust the sensitivity for the microphone you have. (Mic 044-2p is about 33, Mic 068 is about 17).
	Master unit shut off	See why the Master shut off and correct the problem. Turn on the Master and verify the battery level.
A DLT will not sync to Master 1	Out of Range	Bring the unit closer to the Master
	Master is Off	Turn Master unit on
	Master is adjusting settings	On Master, exit settings.
	No/Incorrect Secure Code	Make the secure code the same as the Master
	Wrong Group Number	Make group numbers match the Master
Signal Strength is blinking	The Guest has not found a Master to sync to.	Program at least one unit as the Master or turn on the existing Master. Verify that the Group numbers match. Master must not be in settings menu.
Buttons not functioning	Super lock enabled	Disable super lock
Time of Day Incorrect	Time of Day on Master 1 is Incorrect. (All units sync their time from Master 1)	Set time of day to the correct time on Master 1.

Specifications - DLT 400 Transceiver

Dimensions	4.22"W x 2.60"H x 0.50"D (107.3 mm x 66 mm x 12.6 mm)
Weight	3.3 oz (94 g) including battery
Color	Black/Silver (Front/Back)
Case Material	Black ABS plastic
Battery type	Lithium Polymer with smart charge built into transceiver; 1800 mAh
Battery life	Up to 16 hrs talk time per charge@ 1ch Tx and 1ch Rx
Power Save	Auto Sleep Mode after 5 minutes of no RF signal from compatible devices
Charge time	5 hrs. approx.
System Voltage	OLED 14VDC; RF 5VDC; Logic 3.3 VDC
Operating frequencies	2.4 GHz (ISM band); 2402 – 2476 MHz FHSS
Audio Frequency response (-3dB Level)	Intercom Mode: 100 - 7,200 Hz Other Modes: 100 - 11,500 Hz
SNR	73 dB (A-weighted, default Rx volume with mic input)
THD	0.1 % (Default Volume, 1kHz)
Microphone input	Internal microphone (disabled when MIC jack engaged) and 3.5 mm phone jack (sleeve) with electret microphone bias, adjustable gain with 63dB range.
Line Input	USB-C, Adjustable level
Headphone Output	3.5 mm TRRS headphone jack; 25 mW, R 32 Ω
Audio Output	Headphone: Max SSPL 90 111.8dB (EAR 013), 116.8dB (EAR 041) Line: USB-C, Adjustable level
Range	Up to 900 ft (274 m) (depending upon environmental conditions)
Modulation	FSK
RF Output	19 dBm Typical
Security	87 bit encryption (300 Series Compatible), 87+128 bit Encryption, Encryption PIN, Lock for settings
Side tone	-6 dB below volume, tone variation (Off, Low and High settings available)
Indicators	OLED
LEDs	Red LED around Talk button when enabled; Bi-color, changing green and red LED at top
Charging Connectors	USB-C; Two contacts for use with CHG 412
Compatible Receiver	DLR 400 RCH, DLR 400 ALK, DLT 300 with some limitations and DLR 360 with some limitations
Operating Temperature Range	14° to 113°F (-10° to 45°C)
Approvals	FCC, Industry Canada, CE, RoHS 3, WEEE, RCM, ANATEL, KC, Giteki
Warranty	2 years parts and labor (90 days on accessories); 6 months on internal battery

NOTE: SPECIFICATIONS SUBJECT TO CHANGE WITHOUT NOTICE.

Specifications - DLR 400 RCH Receiver

Dimensions	4.22"W x 2.60"H x 0.50"D (107.3 mm x 66 mm x 12.6 mm)
Weight	3.3 oz (94 g) including battery
Color	Black
Battery type	Lithium Polymer with smart charge built into transceiver; 1800 mAh
Battery life	Up to 32 hrs per charge @ 1ch Rx
Power Save	Auto Sleep Mode after 5 minutes of no RF signal from compatible devices
Charge time	5 hrs. approx.
System Voltage	OLED 14VDC; RF 5VDC; Logic 3.3 VDC
Operating frequencies	2.4 GHz (ISM band); 2402 – 2476 MHz FHSS
Audio Frequency response (-3dB Level)	Intercom Mode: 100 - 7,200 Hz Other Modes: 100 - 11,500 Hz
SNR	73 dB (A-weighted)
THD	0.1% (Default Volume, 1kHz)
Headphone Output	3.5 mm TRRS headphone jack; 25 mW, R32 Ω
Line Audio Output	USB-C, Adjustable level
Range	Up to 900 ft (274 m) (depending upon environmental conditions)
Modulation	FSK
RF Sensitivity	-92 dBm
Security	87 bit encryption (300 Series Compatible), 87+128 bit Encryption, Encryption PIN, Lock for settings
Indicators	OLED
LEDs	Bi-color, changing green and red LED at top
Charging Connectors	USB-C; Two contacts for use with CHG 412
Compatible Units	DLT 400, DLT 300 with some limitations
Operating Temperature Range	14° to 113°F (-10° to 45°C)
Approvals	FCC, Industry Canada, CE, RoHS 3, WEEE, RCM, ANATEL, KC, Giteki
Warranty	2 years parts and labor (90 days on accessories); 6 months on internal battery

NOTE: SPECIFICATIONS SUBJECT TO CHANGE WITHOUT NOTICE.

Specifications - DLR 400 ALK Receiver

Dimensions:	2.36" W x 3.54" H x 0.63" D (60 mm x 90 mm x 16 mm)
Weight:	1.7 oz. (47 g) without batteries.
Frequency Band:	2.4 GHz (ISM band)
Modulation:	FSK
Case Material:	Black ABS Plastic
Battery Type:	2 x AAA Alkaline Batteries
Battery Life:	Alkaline Disposable (BAT 010-2): Up to 30 hrs
Power Save:	Auto Sleep Mode after 5 minutes of no RF signal from compatible devices
Audio Frequency Response: (-3dB level)	Intercom Mode: 100 – 7,300 Hz Interpretation and other modes: 100-11,200 Hz

SNR:	74 dB (A-weighted)
THD:	0.1% (typical)
Antenna:	Internal
Range:	Up to 900 ft (274 m) (depending upon environmental conditions)
Headphone Audio Output:	3.5 mm TRRS jack with mono output for headphones, earphones, or neckloop 27 mW maximum @32Ω
Display:	LCD shows status: Battery Level, RSSI, Group/Channel #
Temp. Range:	14° – 113°F (-10° to 45°C)
Compatible Units	DLT 400, DLT 300
Approvals:	FCC, Industry Canada, RoHS 3, CE, WEEE, RCM, ANATEL, KC, Giteki
Warranty:	2 years parts and labor (90 days on accessories)

NOTE: SPECIFICATIONS SUBJECT TO CHANGE WITHOUT NOTICE.

Regulatory Statements

FCC

FCC ID: CNMDLT400

FCC Compliance Statement

This equipment has been tested and found to comply with the limits for a Class B digital device, pursuant to Part 15 of the FCC Rules.

These limits are designed to provide reasonable protection against harmful interference in a residential installation.

This equipment generates, uses and can radiate radio frequency energy and, if not installed and used in accordance with the instructions, may cause harmful interference to radio communications. However, there is no guarantee that interference will not occur in a particular installation. If this equipment does cause harmful interference to radio or television reception, which can be determined by turning the equipment off and on, the user is encouraged to try to correct the interference by one of the following measures:

- Reorient or relocate the receiving antenna.
- Increase the separation between the equipment and receiver.
- Connect the equipment into an outlet on a circuit different from that to which the receiver is connected.
- Consult the dealer or an experienced radio/TV technician for help.

This device complies with Part 15 of the FCC Rules. Operation is subject to the following two conditions:

1. This device may not cause harmful interference, and
2. This device must accept any interference received, including interference that may cause undesired operation.

Caution: Any changes or modifications to the equipment not expressly approved by the party responsible for compliance could void your authority to operate the equipment.

SAR Requirement

This equipment complies with FCC radiation exposure limits set forth for an uncontrolled environment.

This product meets the applicable national or international RF exposure guidance (SAR guideline) when used normally against your head or, when worn or carried, at a distance of 0.5 cm from the body. The SAR guideline includes a considerable safety margin designed to assure the safety of all persons, regardless of age and health.

ISED

IC ID: 1360A-DLT400

Innovation, Science and Economic Development Canada Statement

This equipment complies with IC RSS-102 radiation exposure limits set forth for an uncontrolled environment.

Operation is subject to the following two conditions:

1. this device may not cause harmful interference, and
2. this device must accept any interference received, including interference that may cause undesired operation

Cet équipement est conforme aux limites d'exposition de rayonnement d'IC RSS-102 déterminées pour un environnement non contrôlé. Cet

Son utilisation est soumise aux deux conditions suivantes:

1. Cet appareil ne doit pas causer d'interférences et
2. il doit accepter toutes interférences reçues, y compris celles susceptibles d'avoir des effets indésirables sur son fonctionnement.

SAR Requirement

This product meets the applicable national or international RF exposure guidance (SAR guideline) when used normally against your head or, when worn or carried, at a distance of 0.5 cm from the body. The SAR guideline includes a considerable safety margin designed to assure the safety of all persons, regardless of age and health.

Ce produit est conforme aux directives nationales ou internationales sur l'exposition aux fréquences radioélectriques (directives SAR) en vigueur lorsqu'il est utilisé normalement contre la tête ou, porté ou porté, à une distance de 0,5 cm du corps.

La directive SAR inclut une marge de sécurité considérable conçue pour assurer la sécurité de toutes les personnes, indépendamment de leur âge et de leur santé.

European Union

Hereby, Williams AV declares that the transceiver is in compliance with Directive 2014/53/EU and other Union harmonization as applicable. The full text of the EU declaration of conformity is available by contacting Williams AV at the following email address: regulatory@williamsav.com

Japanese Statements



この装置は、クラスA機器です。この装置を住宅環境で使用すると電波妨害を引き起こすことがあります。この場合には使用者が適切な対策を講ずるよう要求されることがあります。VCCI-A

This is a Class A equipment. Operation of this equipment in a residential environment could cause radio interference. In such a case, the user may be required to take corrective actions. VCCI-A



R 210-133739

Korean Identification Numbers



R-C-WSa-DLT400
R-R-WSa-DLR400RCH

Brazilian Statements

These units have been tested and certified by an independent party, Anatel, in Brazil.



ANATEL: 08891-19-09817

Este equipamento não tem direito à proteção contra interferência prejudicial e não pode causar interferência em sistemas devidamente autorizados.

Agência Nacional de Telecomunicações

2-Year Warranty

Williams AV products are engineered, designed, and manufactured under carefully controlled conditions to provide you with many years of reliable service.

Williams AV warrants the Digi-Wave system against defects in materials and workmanship under normal use and conditions for 2-years from the product's date of purchase.

This warranty is available to the original end purchaser of the product and CAN BE transferred to subsequent purchasers of the product.

Microphones, earphones, headphones, batteries, chargers, cables, carry cases, and most other accessory products carry a 90-day warranty.

Williams AV has no control over the conditions under which this product is used. Williams AV, therefore, disclaims all warranties not set forth above, both express and implied, with respect to the Digi-Wave System, including but not limited to, any implied warranty of merchantability or fitness of use of such equipment including, without limitation, any warranty that the use of such equipment for any purpose will comply with applicable laws and regulations. Williams AV shall not be liable to any person or entity for any medical expenses or any direct, incidental or consequential damages caused by any use, defect, failure or malfunctioning of the product, whether a claim for such damages is based upon warranty, contract, tort or otherwise.

The sole remedy for any defect, failure or malfunction of the products is replacement of the product. No person has any authority to bind Williams AV to any representation or warranty with respect to the Digi-Wave System. Unauthorized repairs or modifications will void the warranty. This warranty is void if damage occurred because of misuse, or if the product has been repaired or modified by anyone other than a factory authorized service technician. Warranty does not cover normal wear and tear on the product or any other physical damage unless the damage was the result of a manufacturing defect. Williams AV is not liable for consequential damages due to any failure of equipment to perform as intended. Williams AV shall bear no responsibility or obligation with respect to the manner of use of any equipment sold by it.

This warranty does not cover reimbursement for your costs of removing and transporting the product for warranty service evaluation or installation of any replacement product provided under this warranty.

The exclusions and limitations set out above are not intended to, and should not be construed so as to contravene mandatory provisions of applicable law. If any part or term of this Disclaimer of Warranty is held to be illegal, unenforceable, or in conflict with applicable law by a court of competent jurisdiction, the validity of the remaining portions of this Disclaimer of Warranty shall not be affected, and all rights and obligations shall be construed and enforced as if this warranty did not contain the particular part or term held to be invalid. The terms of the warranty are governed by the laws of the State of Minnesota.

Prices and the specifications of the products are subject to change without notice.

For Complete Warranty Statement go to: www.williamsav.com/warranty-statement

NOTICE: Williams AV products are NOT designed for use in extreme temperature, humidity or chemical environments. The introduction of chemicals such as chlorine, salt water or human sweat into the product will cause damage to the circuitry. Damage due to these causes is NOT covered under the Product Warranty.

If you experience difficulty with your system, call Toll-Free for Customer Assistance

1-800-843-3544 (U.S.A.) or +1 952 943 2252 (Outside the U.S.A.)

If it is necessary to return the system for service, your Customer Service Representative will give you a Return Authorization Number (RA) and shipping instructions.

Pack the system carefully and send it to:

**Williams AV
Attn: Repair Dept.
10300 Valley View Road
Eden Prairie, MN 55344**

www.tourguidesystem.co.uk

WILLIAMS AV
info@williamsav.com / www.williamsav.com
800-843-3544 / INTL: +1-952-943-2252